

VideoFlex G4

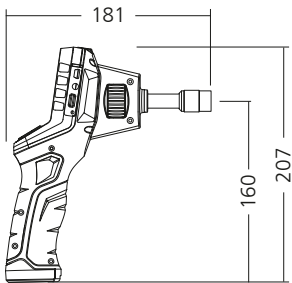

DE 02

EN 11

NL 20

DA 29

FR 38

ES 47

IT 56

PL

FI

PT

SV

NO

TR

RU

UK

CS

ET

RO

BG

EL

JP

Laserliner

Lesen Sie die Bedienungsanleitung, das beiliegende Heft „Garantie- und Zusatzhinweise“ sowie die aktuellen Informationen und Hinweise im Internet-Link am Ende dieser Anleitung vollständig durch. Befolgen Sie die darin enthaltenen Anweisungen. Diese Unterlage ist aufzubewahren und bei Weitergabe der Lasereinrichtung mitzugeben.

Funktion / Verwendung

Das professionelle Videoskopie-System VideoFlex G4 eignet sich in Verbindung mit einer wechselbaren Kameraeinheit für die einfache visuelle Überprüfung schwer zugänglicher Stellen in Rohren, Hohlräumen, Schächten, Mauerwerk und Kraftfahrzeugen. Zur Auswertung und Dokumentation können die Bild- und Videoaufnahmen auf der SDHC-Speicherkarte gespeichert werden.

Allgemeine Sicherheitshinweise

- Setzen Sie das Gerät ausschließlich gemäß dem Verwendungszweck innerhalb der Spezifikationen ein.
- Die Messgeräte und das Zubehör sind kein Kinderspielzeug. Vor Kindern unzugänglich aufbewahren.
- Baulich darf das Gerät nicht verändert werden.
- Setzen Sie das Gerät keiner mechanischen Belastung, enormen Temperaturen, Feuchtigkeit oder starken Vibrationen aus.
- Das Gerät darf nicht mehr verwendet werden, wenn eine oder mehrere Funktionen ausfallen oder die Batterieladung schwach ist.
- Achten Sie beim Außeneinsatz darauf, dass das Gerät nur unter entsprechenden Witterungsbedingungen bzw. bei geeigneten Schutzmaßnahmen eingesetzt wird.
- Die LCD-Einheit darf nicht in Wasser getaucht werden. Das Basisgerät darf nicht mit Flüssigkeit in Berührung kommen.
- Es ist unbedingt darauf zu achten, dass die VideoFlex G4 nicht in Kontakt mit Chemikalien, Spannung, beweglichen oder heißen Gegenständen kommt. Dies kann zur Beschädigung des Gerätes und auch zu schweren Verletzungen des Bedieners führen.
- Die VideoFlex G4 darf nicht für medizinische Untersuchungen / Personenuntersuchung verwendet werden.
- Bitte beachten Sie die Sicherheitshinweise von lokalen bzw. nationalen Behörden zur sachgemäßen Benutzung des Gerätes.
- Das Gerät ist nicht zur Messung in der Nähe von gefährlicher Spannung geeignet. Daher bei Messungen in der Nähe elektrischer Anlagen immer auf die Spannungsfreiheit leitfähiger Teile achten. Die Spannungsfreiheit und Sicherung gegen Wiedereinschalten muss durch geeignete Maßnahmen gewährleistet sein.

Sicherheitshinweise

Umgang mit elektromagnetischer Strahlung

- Das Messgerät hält die Vorschriften und Grenzwerte für die elektromagnetische Verträglichkeit gemäß EMV-Richtlinie 2014/30/EU ein.
- Lokale Betriebseinschränkungen, z.B. in Krankenhäusern, in Flugzeugen, an Tankstellen oder in der Nähe von Personen mit Herzschrittmachern sind zu beachten. Die Möglichkeit einer gefährlichen Beeinflussung oder Störung von und durch elektronische Geräte ist gegeben.

Hinweise zur Wartung und Pflege

Reinigen Sie alle Komponenten mit einem leicht angefeuchteten Tuch und vermeiden Sie den Einsatz von Putz-, Scheuer- und Lösungsmitteln. Entnehmen Sie die Batterie/n vor einer längeren Lagerung. Lagern Sie das Gerät an einem sauberen, trockenen Ort.

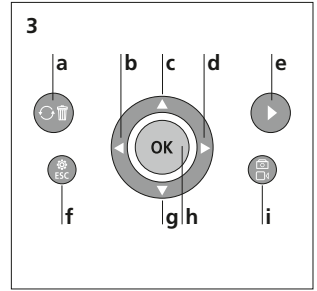
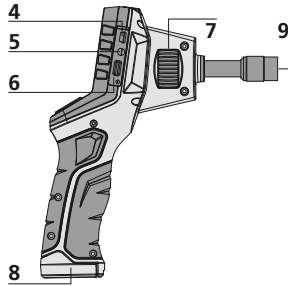
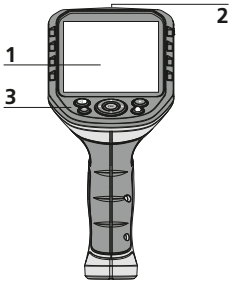

- 1 LC-Display
 - 2 ON/OFF
 - 3 Direkttasten
 - 4 Schnittstelle USB Typ C
 - 5 Video-Ausgang
 - 6 Steckplatz Micro-SD-Karte
 - 7 Drehrad Kameraeinheit
 - 8 Akkufach
 - 9 Anschluss Kameraeinheit
- a Rotation 180° / Spiegelung / Aufnahmen löschen
 - b Menü-Steuerung / LED-Beleuchtung -
 - c Menü-Steuerung / Zoom +
 - d Menü-Steuerung / LED-Beleuchtung +
 - e Mediengalerie
 - f Einstellungsmodus / Abbruch
 - g Menü-Steuerung / Zoom -
 - h Auslöser / Aufnahme / Bestätigen
 - i Umschaltung Bild / Video

Aufnahmemodus Bild

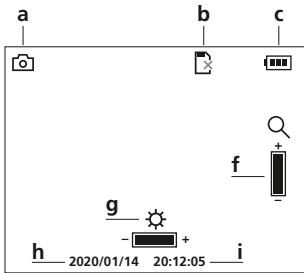

Aufnahmemodus Video

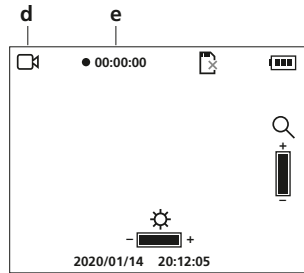

- a Aufnahme Bild
- b SD-Karte einlegen
- c Batteriestatus
- d Aufnahme Video
- e REC: Aufnahme läuft
- f Zoom
- g LED-Beleuchtung
- h aktuelles Datum
- i aktuelle Uhrzeit

Wiedergabemodus Bild

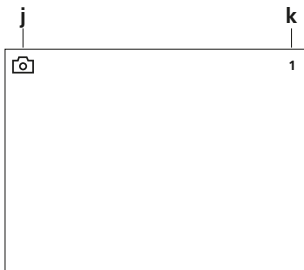



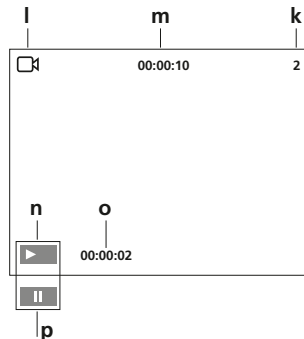



Wiedergabemodus Video



- j Aufnahme Bild
- k Nummer der Aufnahme
- l Aufnahme Video
- m Aufnahmedauer
- n Play
- o abgespielte Dauer
- p Pause

Einstellungsmodus

Einstellungen	
 Format	— q
 Farbe oder Schwarz / Weiß	— r
 Sprache	— s
 Auto Aus	— t

Einstellungen	
 Standardeinstellungen	— u
 Datum/Uhrzeit	— v
 Version	— w

- q** Datenträger formatieren
- r** Farbmodus wechseln
- s** Sprache ändern (EN, JP, FR, DE, IT, PT, NL, ES)
- t** Automatische Abschaltung
- u** Werkseinstellung
- v** Datum/Uhrzeit einstellen
- w** Firmware-Version

Inbetriebnahme

1 Anschluss Flexschlauch

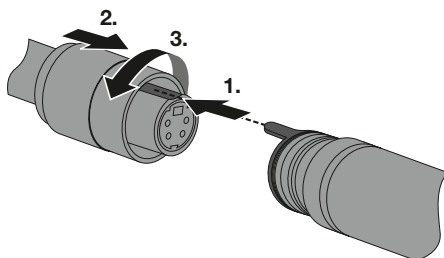

2 ON/OFF

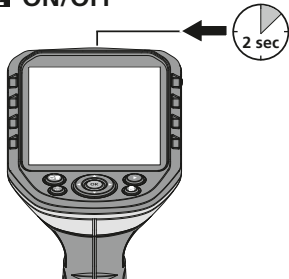

RESET

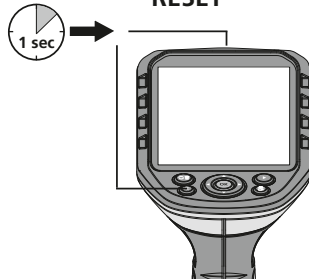

3 Micro-SD-Karte einlegen

Zum Einlegen einer Micro-SD-Karte zuerst die Gummabdeckung öffnen und danach die Speicherkarte gemäß Abbildung einsetzen. Ohne Speichermedium sind keine Aufzeichnungen möglich.

! Vor Entnahme der Micro-SD-Karte muss das Gerätausgeschaltet werden.

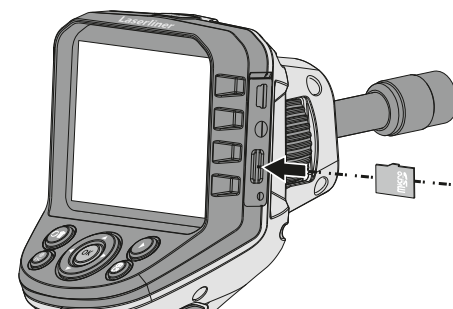

4 Einstellungsmodus

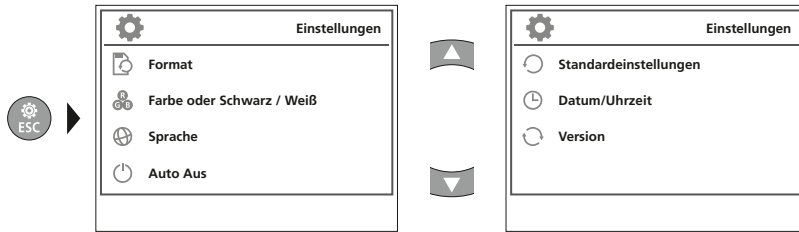

Um wieder in den Aufnahmemodus zu gelangen, die Taste ESC mehrfach drücken.

a. Datenträger formatieren

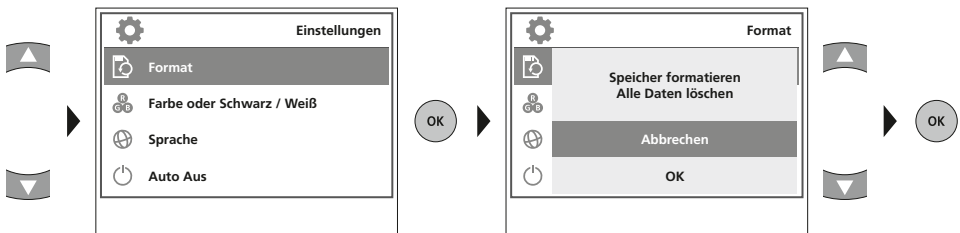

! Alle Daten auf der SD-Karte werden gelöscht. Dieser Vorgang kann nicht widerrufen werden. Es erfolgt keine weitere Abfrage zur Bestätigung des Vorganges.

b. Farbmodus wechseln

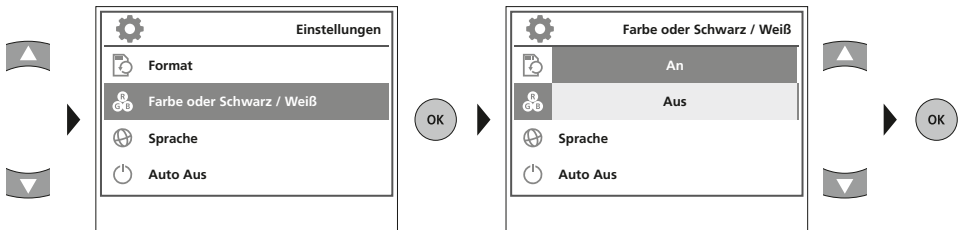

c. Sprache ändern (EN, JP, FR, DE, IT, PT, NL, ES)

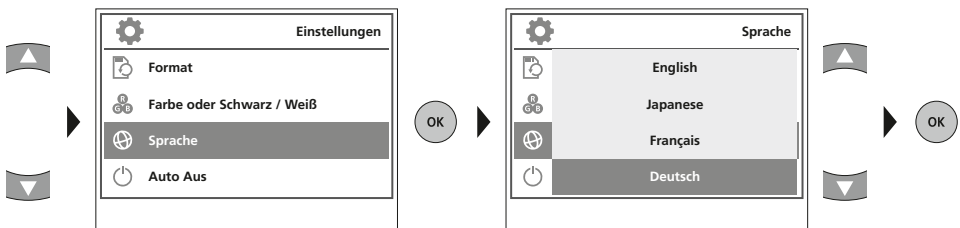

d. Automatische Abschaltung

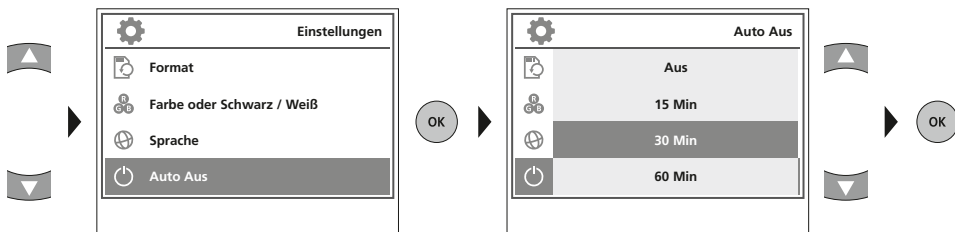

e. Werkseinstellung

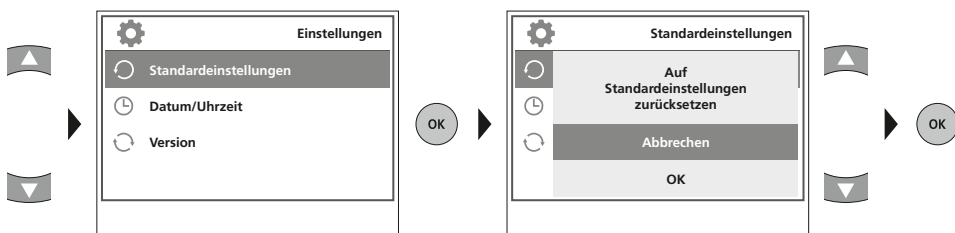

f. Datum/Uhrzeit einstellen

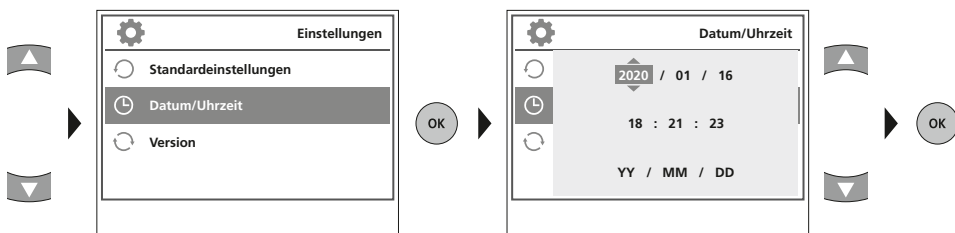

g. Firmware-Version

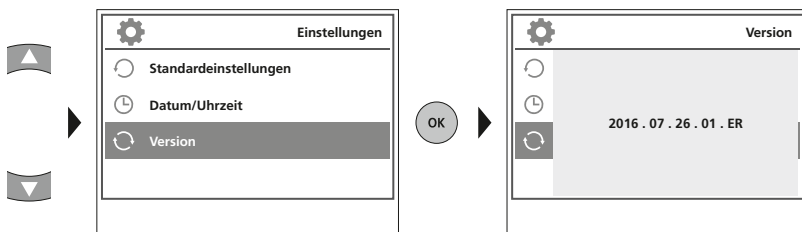

5 Aufnahmemodus



Bild-/Videoaufnahmen

Kamerakopf am Flexschlauch ausrichten und an die gewünschte Position führen. Bei schlechten Lichtverhältnissen LED-Beleuchtung einschalten. Weiter entfernte oder kleine Objekte heranzoomen. Durch die manuelle Bildrotation kann das Bild auf dem Monitor um 180° gedreht werden. Durch kurzes Betätigen der OK-Taste wird das Bild oder die Videoaufnahme aufgenommen und auf der SD-Karte gespeichert. Erneutes Drücken beendet die Aufnahme.

a. Umschaltung Aufnahme Bild / Video

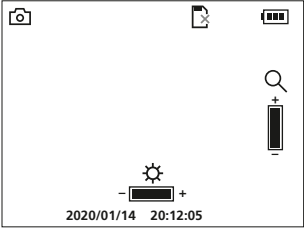
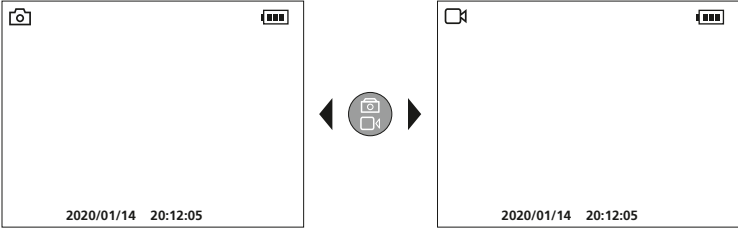

b. LED-Beleuchtung

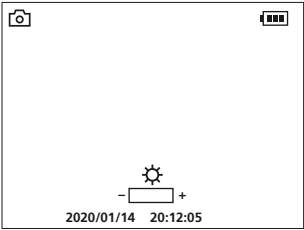

1x =	20%
2x =	40%
3x =	60%
4x =	80%
5x =	100%

c. Zoom

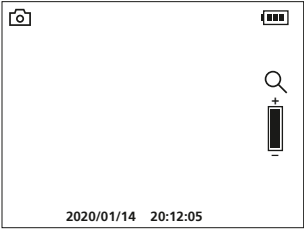

1x =	120%
2x =	140%
3x =	160%
4x =	180%
5x =	200%

d. Bildrotation / Spiegelung

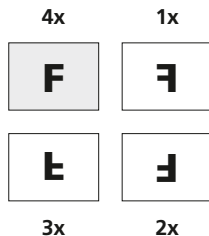
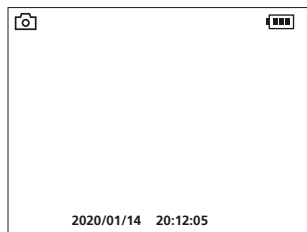

vom Ausgangsbild

1x = horizontale Spiegelung

2x = Drehung 180°

3x = vertikale Spiegelung

4x = Ausgangsbild

e. Bild aufnehmen

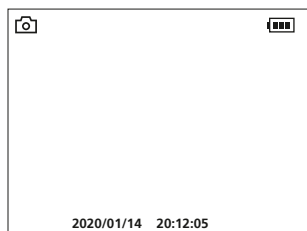

f. Videoaufnahme starten / beenden

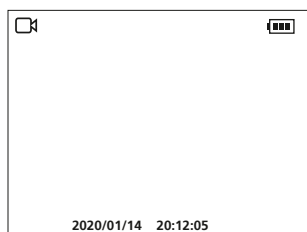

START

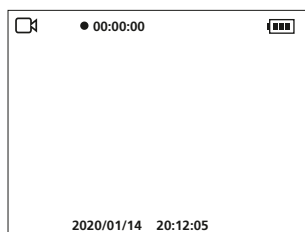

STOPP

6 Manuelle Bildausrichtung

mit starrer Kameraeinheit

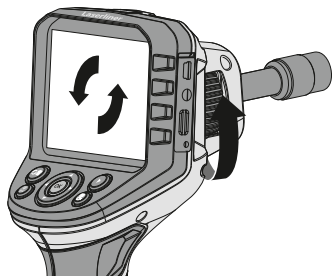

mit flexibler Kameraeinheit

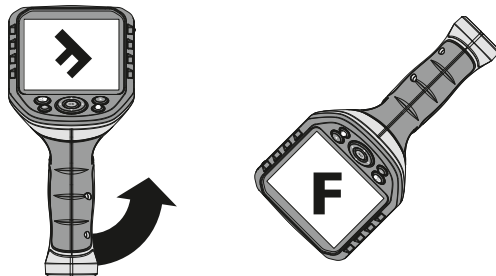

7 Wiedergabemodus

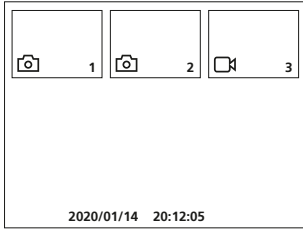

Wiedergabe von Bild-/Videoaufnahmen

Durch Drücken der Taste „e“ wird die Mediengalerie aufgerufen. Bestätigen mit „OK“ zeigt das ausgewählte Bild oder Video im Vollbildmodus. Mit den Pfeiltasten kann in der Mediengalerie und im Vollbildmodus navigiert werden. Durch Drücken der Taste „f“ wird der Wiedergabemodus geschlossen.

a. Navigieren

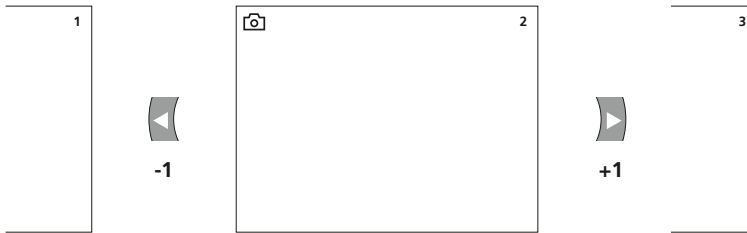

b. Aufnahme löschen

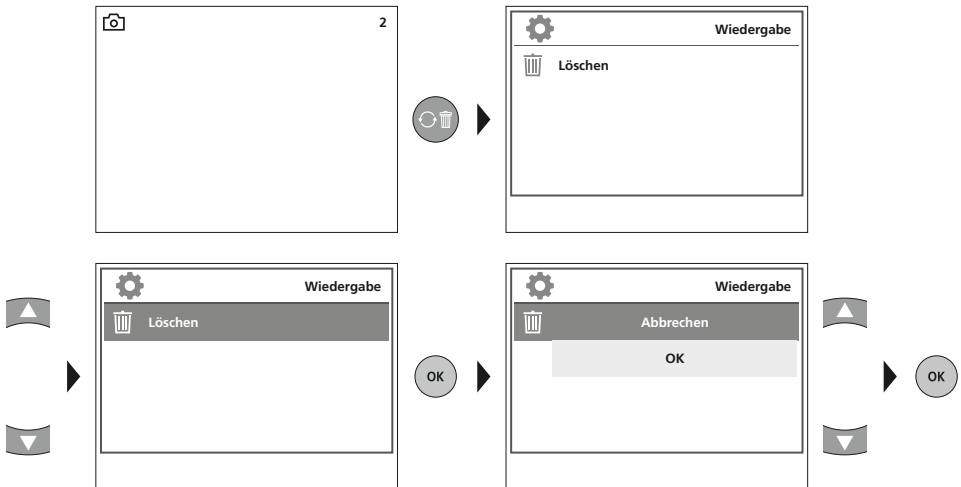

! Aufnahmen können nur im Vollbildmodus gelöscht werden. Der Löschvorgang kann nicht widerrufen werden.

! Über die Formatierung des Datenträgers können alle Dateien und Ordner gelöscht werden. Siehe hierzu Punkt „4 a. Datenträger formatieren“.

c. Wiedergabe

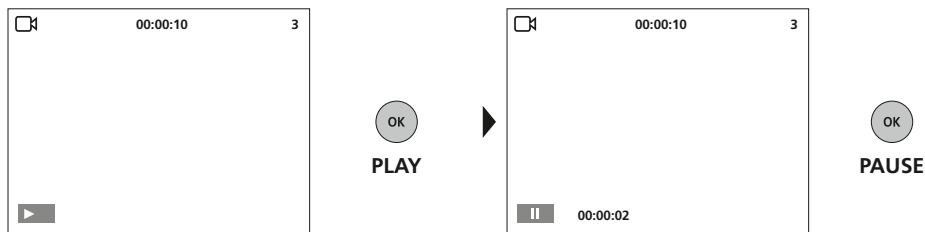

Durch Drücken der Taste ESC wird die Wiedergabe gestoppt.

USB-Datenübertragung

Die gespeicherten Daten auf der SD-Karte können entweder mit einem passenden Kartenlesegerät oder über die USB-Schnittstelle auf den PC übertragen werden. Informationen zur Verbindung zwischen Computer und Kartenadapter bzw. Kartenleser finden Sie im Handbuch zu Ihrem Kartenleser.

Netz-/Ladegerät anschließen

Schließen Sie zum Laden des Gerätes das mitgelieferte Netz-/Ladegerät in die Schnittstelle USB Typ C „4“ und verbinden es mit einer entsprechenden Stromquelle.

Technische Daten

Technische Änderungen vorbehalten. 21W09

Bildschirmtyp	3,5" TFT-Farbdisplay
Auflösung Display	320 x 240 Pixel
Auflösung Bild / Video	640 x 480 Pixel
Bildformat / Videoformat	JPEG, AVI
Speicher	Micro-SD Speicherkarte bis 16 GB
Anschlüsse	USB Typ C, Video-Ausgang Cinch
Stromversorgung	Li-Ion Akkupack 3,7V / 2,8Ah
Betriebsdauer	ca. 5 Std.
Arbeitsbedingungen	0°C ... 45°C, Luftfeuchtigkeit max. 20 ... 85% rH, nicht kondensierend, Arbeitshöhe max. 4000 m über NN (Normalnull)
Lagerbedingungen	-10°C ... 60°C, Luftfeuchtigkeit max. 80% rH
Abmessungen (B x H x T)	181 x 207 x 96 mm
Gewicht	342 g (inkl. Akkupack)

EU-Bestimmungen und Entsorgung

Das Gerät erfüllt alle erforderlichen Normen für den freien Warenverkehr innerhalb der EU.

Dieses Produkt ist ein Elektrogerät und muss nach der europäischen Richtlinie für Elektro- und Elektronik-Altgeräte getrennt gesammelt und entsorgt werden.

Weitere Sicherheits- und Zusatzhinweise unter: <http://laserliner.com/info?an=AGG>





Completely read through the operating instructions, the „Warranty and Additional Information“ booklet as well as the latest information under the internet link at the end of these instructions. Follow the instructions they contain. This document must be kept in a safe place and passed on together with the device.

Function / Application

This professional video inspection system VideoFlex G4 combined with an exchangeable camera unit is suitable for easy visual inspection of hard-to-reach places in pipes, cavities, shafts, masonry and motor vehicles. Images and videos can be stored on the SDHC memory card for analysis and documentation.

General safety instructions

- The device must only be used in accordance with its intended purpose and within the scope of the specifications.
- The measuring tools and accessories are not toys. Keep out of reach of children.
- The structure of the device must not be modified in any way.
- Do not expose the device to mechanical stress, extreme temperatures, moisture or significant vibration.
- The device must no longer be used if one or more of its functions fail or the battery charge is weak.
- When using the device outdoors, make sure that the weather conditions are appropriate and/or that suitable protection measures are taken.
- The LCD unit must not be immersed in water. The base unit must not come in contact with liquids.
- It is absolutely vital to ensure that the VideoFlex G4 does not come into contact with chemicals, voltage, moving or hot objects. This can damage the device and put its user at risk of serious injury.
- The VideoFlex G4 must not be used for medical examinations / examining people.
- Please ensure compliance with the safety regulations set out by local and national authorities with regard to the correct and proper use of the device.
- The unit is not suitable for taking measurements close to dangerous voltages. Therefore always make sure that conductive parts are at zero potential when carrying out measurements in the vicinity of electrical systems. Safe isolation from the power supply and precautions to prevent systems being switched on again must be ensured by implementing suitable measures.

Safety instructions

Dealing with electromagnetic radiation

- The measuring device complies with electromagnetic compatibility regulations and limit values in accordance with EMC-Directive 2014/30/EU.
- Local operating restrictions – for example, in hospitals, aircraft, petrol stations or in the vicinity of people with pacemakers – may apply. Electronic devices can potentially cause hazards or interference or be subject to hazards or interference.

Information on maintenance and care

Clean all components with a damp cloth and do not use cleaning agents, scouring agents and solvents. Remove the battery(ies) before storing for longer periods. Store the device in a clean and dry place.

Laserliner

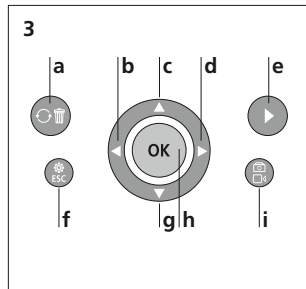
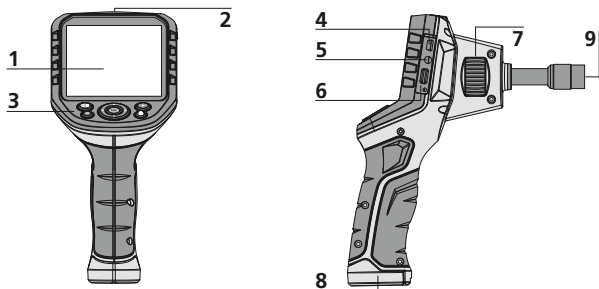

- 1 LCD
- 2 ON/OFF
- 3 Hot keys
- 4 Type C USB interface
- 5 Video output
- 6 Micro SD card slot
- 7 Camera unit with rotary control
- 8 Battery compartment
- 9 Camera unit connection

- a Rotation 180° / Mirroring / Delete recording
- b Menu control / LED lighting -
- c Menu control / Zoom in
- d Menu control / LED lighting +
- e Media gallery

- f Settings mode / Cancel
- g Menu control / Zoom out
- h Trigger / Record / Confirm
- i Image / video selection

Image record mode

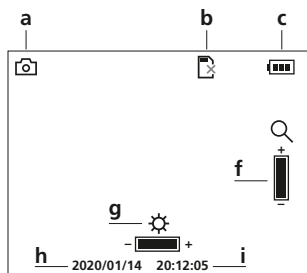

Video record mode

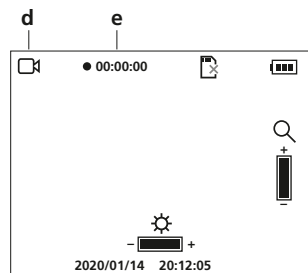

- a Image recording
- b Insert SD card
- c Battery status
- d Video recording
- e REC: Recording
- f Zoom
- g LED lighting
- h Current date
- i Current time

Image playback mode

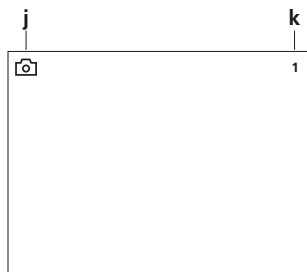



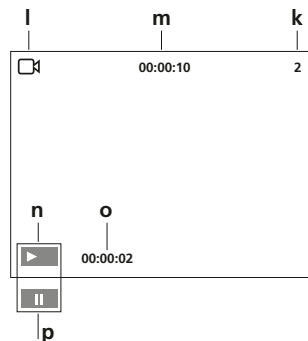





Video playback mode



- j Image recording
- k Number of image
- l Video recording
- m Recording time
- n Play
- o Play duration
- p Pause

Settings mode

Settings	
	
 Formatting	— q
 Colour or black/white	— r
 Language	— s
 Automatic switch-off	— t

Settings	
	
 Standard settings	— u
 Date/time	— v
 Version	— w

- q** Format data medium
- r** Select colour mode
- s** Select language (EN, JP, FR, DE, IT, PT, NL, ES)
- t** Auto shutdown
- u** Factory setting
- v** Set date/time
- w** Firmware version

First use

1 Connection for flex cable

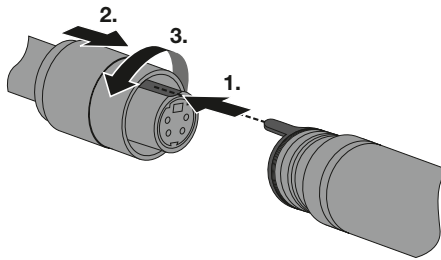

2 ON/OFF

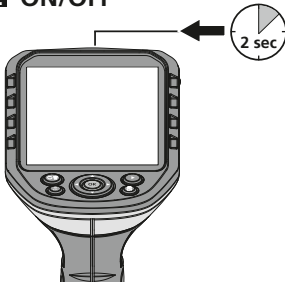

RESET

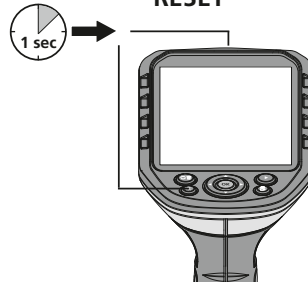

3 Inserting micro-SD card

To insert a micro-SD card, first open the rubber cover and then insert the memory card as illustrated. You cannot record anything without a storage medium.

! The device must be switched off before removing the micro-SD.

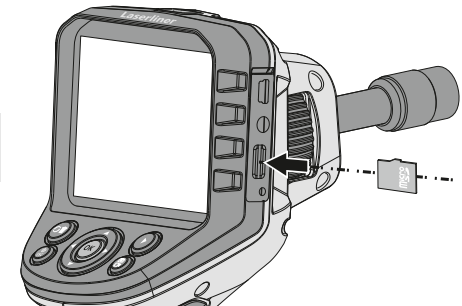

4 Settings mode

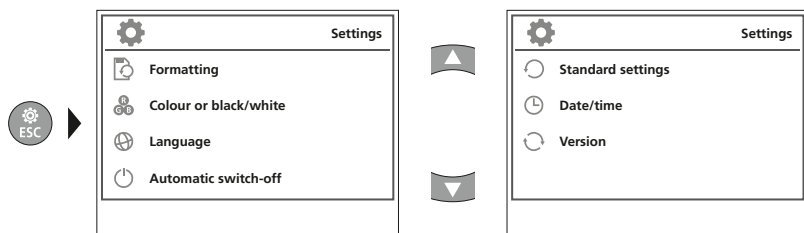

To return to recording mode, press the ESC button several times.

a. Format data medium

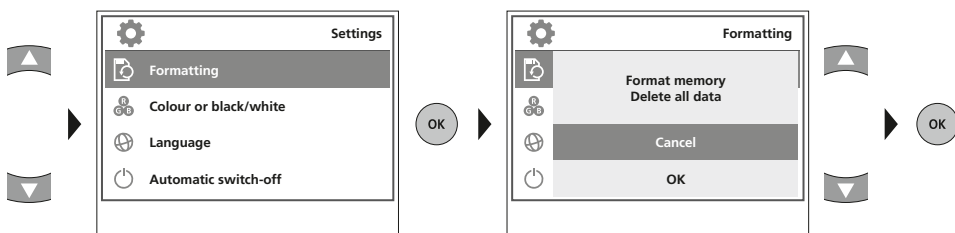

! All data on the SD card will be deleted. This procedure cannot be undone. There is no further prompt to confirm deletion.

b. Select colour mode

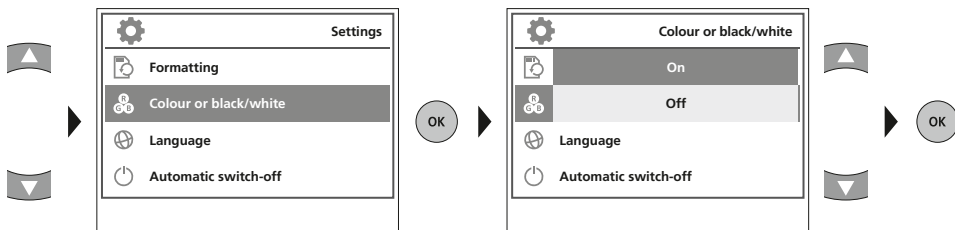

c. Select language (EN, JP, FR, DE, IT, PT, NL, ES)

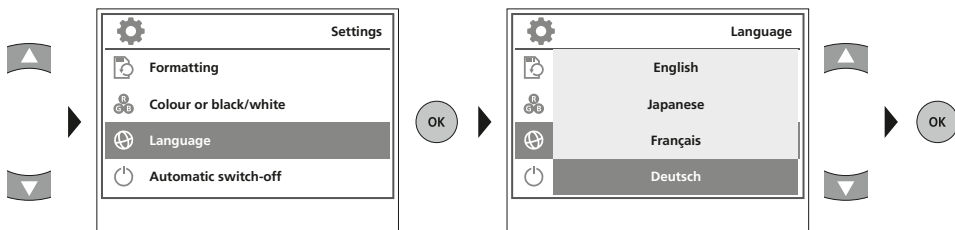

d. Auto shutdown

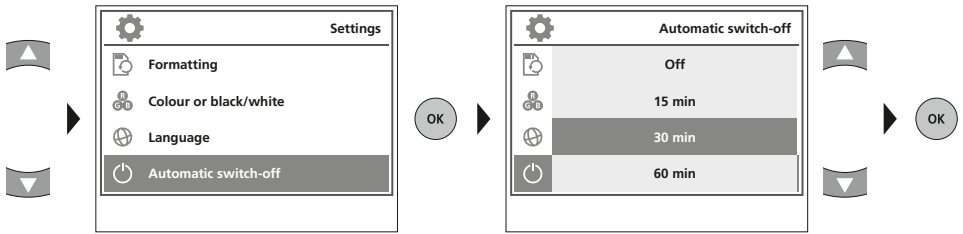

e. Factory setting

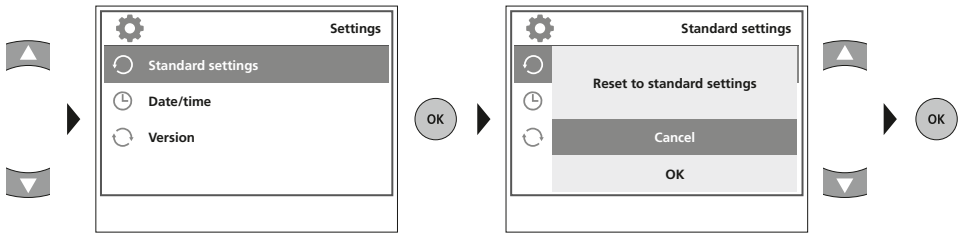

f. Set date/time

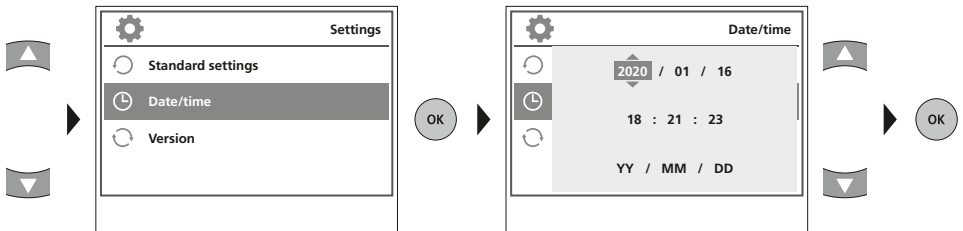

g. Firmware version

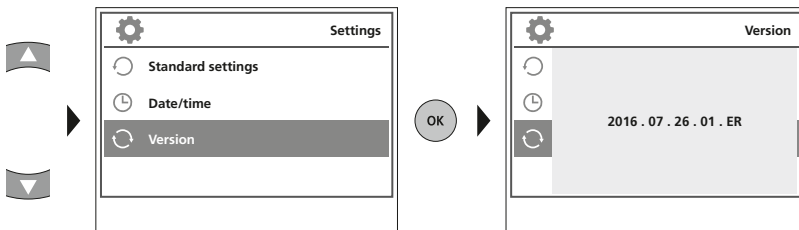

5 Record mode

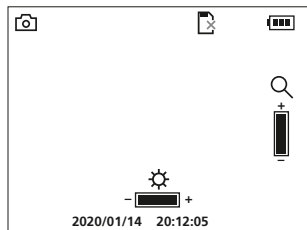

Still images/Video recordings

Line up the camera head on the flex cable and move it to the required position. If lighting conditions are poor, switch on the LED lighting. Zoom in on distant or small objects. The manual image rotation function enables the image to be rotated by 180° on the monitor. Briefly press the OK button to take a still image or make a video recording and save it to the SD card. Press the button again to stop recording.

a. Image/video recording selection

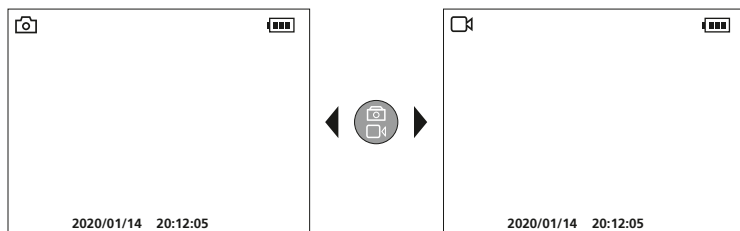

b. LED lighting

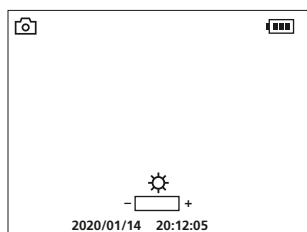

1x	=	20%
2x	=	40%
3x	=	60%
4x	=	80%
5x	=	100%

c. Zoom

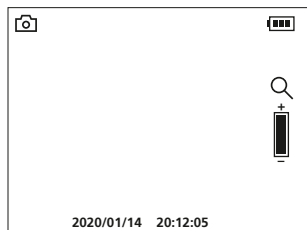

1x	=	120%
2x	=	140%
3x	=	160%
4x	=	180%
5x	=	200%

d. Image rotation / Mirroring

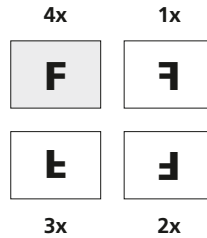
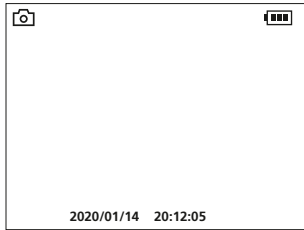

From the original image

1x = horizontal mirroring

2x = Rotation 180°

3x = vertical mirroring

4x = Original image

e. Record still image

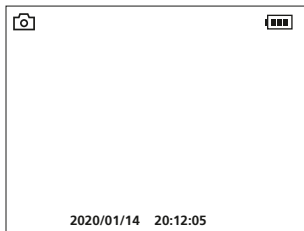

f. Start/stop video recording

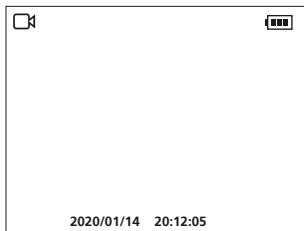

START

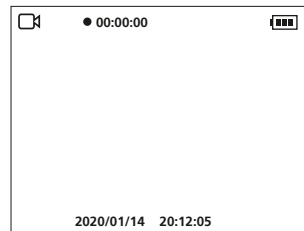

STOP

6 Manual image alignment

with fixed camera unit

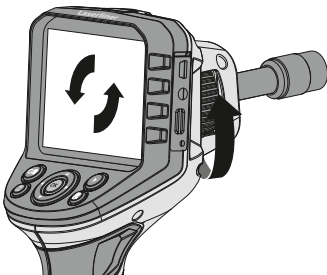

with flexible camera unit

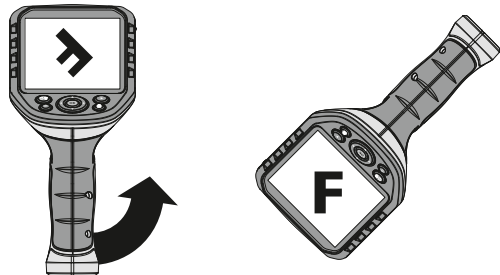

7 Playback mode

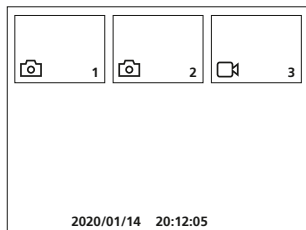

Playback of still images/video recordings

Press the „e“ button to call up the media gallery. Confirm with „OK“ to show the selected image or video in full screen mode. Use the arrow keys to navigate in the media gallery and full screen mode. Press the „f“ button to exit playback mode.

a. Navigation

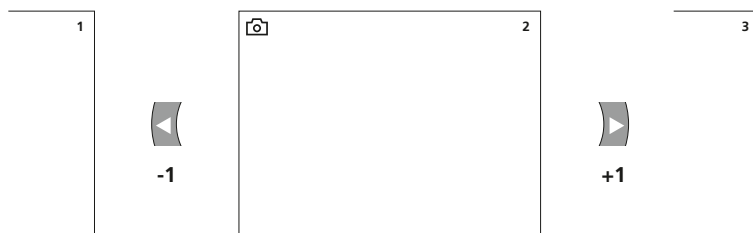

b. Delete recording

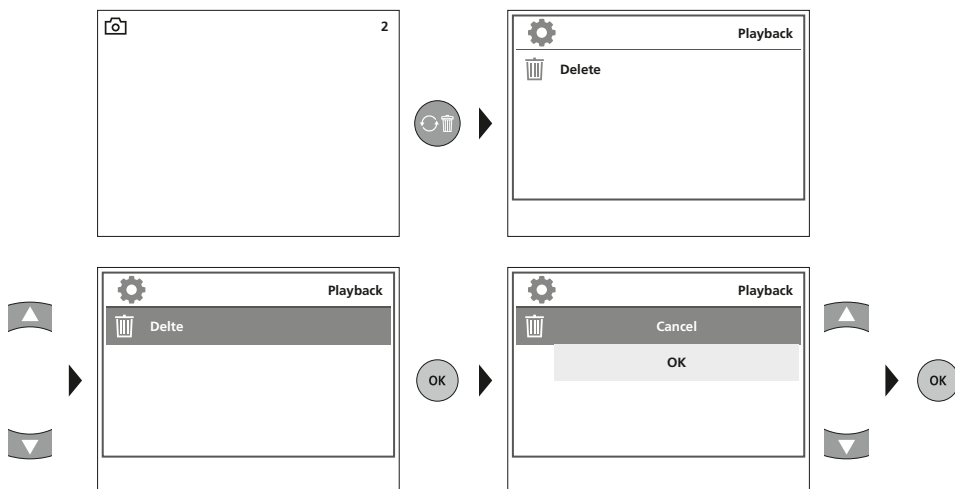

! Recordings can only be deleted in full screen mode. Deleting cannot be undone.

! All files and folders can be deleted by reformatting the data medium. Refer to „4 a. Format Data Medium“.

c. Playback

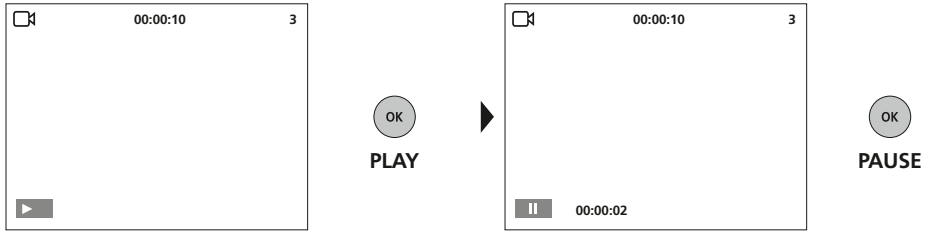

Press the „ESC“ button to stop playback.

USB data transfer

Data saved on the SD card can be transferred to PC either with a suitable card reader or directly via the USB port. Please refer to the manual supplied with your card reader for information about connecting your card adapter or card reader to a PC.

Connect power supply/battery charger

To charge the device, plug the supplied power supply/charger into the type C USB „4“ interface and connect it to a suitable power source.

Technical Data		Technical revisions reserved. 21W09
Screen type	3.5" TFT colour display	
Display resolution	320 x 240 pixels	
Image/Video resolution	640 x 480 pixels	
Image format/Video format	JPEG / AVI	
Memory	Micro-SD memory card up to 16 GB	
Connections	USB type C, RCA video output	
Power supply	Li-ion battery pack 3.7V / 2.8Ah	
Operating time	approx. 5 hours	
Operating conditions	0°C ... 45°C, max. humidity 20 ... 85% rH, no condensation, max. working altitude 4000 m above sea level	
Storage conditions	-10°C ... 60°C, max. humidity 80% rH	
Dimensions (W x H x D)	181 x 207 x 96 mm	
Weight	342 g (incl. battery pack)	

EU directives and disposal

This device complies with all necessary standards for the free movement of goods within the EU.

This product is an electric device and must be collected separately for disposal according to the European Directive on waste electrical and electronic equipment.

Further safety and supplementary notices at: <http://laserliner.com/info?an=AGG>





Lees de handleiding, de bijgevoegde brochure 'Garantie- en aanvullende aanwijzingen' evenals de actuele informatie en aanwijzingen in de internet-link aan het einde van deze handleiding volledig door. Volg de daarin beschreven aanwijzingen op. Bewaar deze documentatie en geef ze door als u het apparaat doorgeeft.

Functie / toepassing

Het professionele video-inspectiesysteem VideoFlex G4 is, in combinatie met een uitwisselbare camera-eenheid, geschikt voor de eenvoudige visuele controle van moeilijk toegankelijke plekken in buizen, holle ruimten, schachten, muurwerk en motorvoertuigen. Voor evaluatie en documentatie kunnen de beeld- en video-opnamen worden opgeslagen op de SDHC-geheugenkaart.

Algemene veiligheidsaanwijzingen

- Gebruik het apparaat uitsluitend doelmatig binnen de aangegeven specificaties.
- De meetapparaten en het toebehoren zijn geen kinderspeelgoed. Buiten het bereik van kinderen bewaren.
- De bouwwijze van het apparaat mag niet worden veranderd!
- Stel het apparaat niet bloot aan mechanische belasting, extreme temperaturen, vocht of sterke trillingen.
- Het apparaat mag niet meer worden gebruikt als een of meerdere functies uitvallen of de batterijlading zwak is.
- Let bij gebruik buitenshuis op dat het apparaat alleen onder dienovereenkomstige weersomstandigheden resp. na het treffen van geschikte veiligheidsmaatregelen toegepast wordt.
- De LCD-eenheid mag niet onder water worden gedompeld. Het basisapparaat mag niet in contact komen met vloeistoffen.
- Let absoluut op dat de VideoFlex G4 niet in contact komt met chemicaliën, voltage, beweeglijke of hete voorwerpen. Hierdoor kan het apparaat beschadigd raken, hetgeen kan leiden tot ernstig persoonlijk letsel van de gebruiker.
- De VideoFlex G4 mag niet worden gebruikt voor medische doeleinden / persoonsonderzoek.
- Neem de veiligheidsvoorschriften van lokale resp. nationale instanties voor het veilige en deskundige gebruik van het apparaat in acht.
- Het apparaat is niet geschikt voor de meting in de buurt van gevaarlijke spanning. Let bij metingen in de buurt van elektrische installaties altijd op de spanningsvrijheid van geleidende onderdelen. De spanningsvrijheid en de beveiliging tegen hernieuwd inschakelen moet door middel van geschikte maatregelen gewaarborgd zijn.

Veiligheidsinstructies

Omgang met elektromagnetische straling

- Het meettoestel voldoet aan de voorschriften en grenswaarden voor de elektromagnetische compatibiliteit volgens de EMC-richtlijn 2014/30/EU.
- Plaatselijke gebruiksbeperkingen, bijv. in ziekenhuizen, in vliegtuigen, op pompstations of in de buurt van personen met een pacemaker, moeten in acht worden genomen. Een gevaarlijk effect op of storing van en door elektronische apparaten is mogelijk.

Opmerkingen inzake onderhoud en reiniging

Reinig alle componenten met een iets vochtige doek en vermijd het gebruik van reinigings-, schuur- en oplosmiddelen. Verwijder de batterij(en) voordat u het apparaat gedurende een langere tijd niet gebruikt. Bewaar het apparaat op een schone, droge plaats.

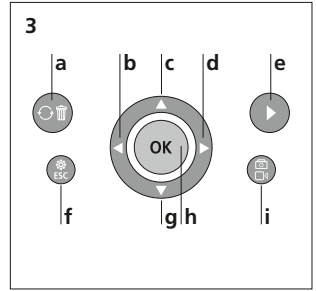
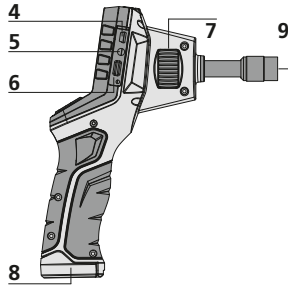
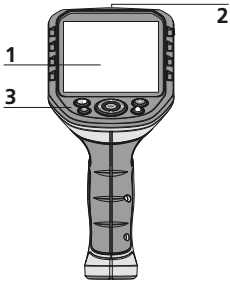

- 1 LC-display
- 2 ON/OFF
- 3 Directe toetsen
- 4 Interface USB type C
- 5 Video-uitgang
- 6 Steekplaats micro-SD-kaart
- 7 Stelwiel camera-eenheid
- 8 Accuvakje
- 9 Aansluiting camera-eenheid

- a Rotatie 180° / Spiegeling / Opnames wissen
- b Menubesturing / LED-verlichting –
- c Menubesturing / + zoom
- d Menubesturing / LED-verlichting +
- e Mediagaleries

- f Instellingsmodus / Annuleren
- g Menubesturing / – zoom
- h Ontspanner / Opname / Bevestigen
- i Omschakeling beeld / video

Opnamemodus beeld

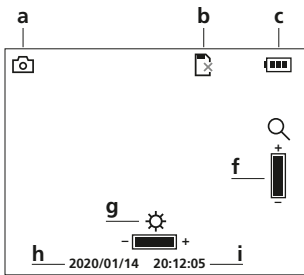

Opnamemodus video

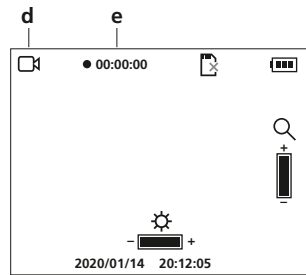

- a Opname beeld
- b SD-kaart plaatsen
- c Batterijstatus
- d Opname video
- e REC: opname loopt
- f Zoom
- g LED-verlichting
- h Actuele datum
- i Actuele tijd

Weergavemodus beeld

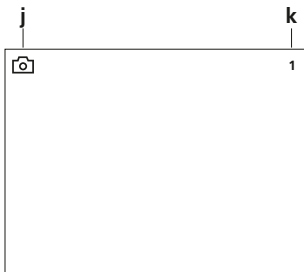



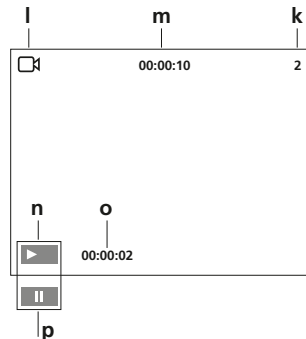



Weergavemodus video



- j Opname beeld
- k Nummer van de opname
- l Opname video
- m Duur van de opname
- n Play
- o afgespeelde duur
- p Pauze

Instellingsmodus

Instellingen	
 Formaat	— q
 Kleur of zwart/wit	— r
 Taal	— s
 Auto Uit	— t

Instellingen	
 Standaardinstellingen	— u
 Datum / tijd	— v
 Versie	— w

- q** Gegevensdrager formatteren
- r** Kleurenmodus wisselen
- s** Taal wijzigen (EN, JP, FR, DE, IT, PT, NL, ES)
- t** Automatische uitschakeling
- u** Fabriekinstelling
- v** Datum / tijd instellen
- w** Firmware-versie

Ingebruikname

1 Aansluiting flexibele slang

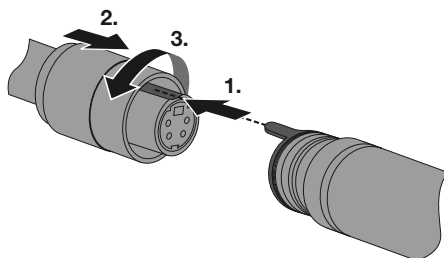

2 ON/OFF

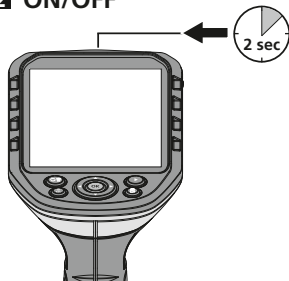

RESET

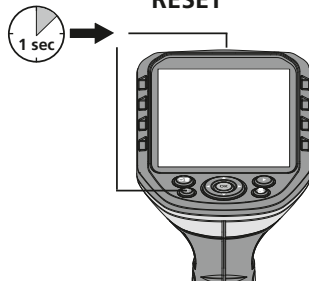

3 Micro SD-kaart plaatsen

Om een micro SD-kaart te plaatsen opent u eerst de rubberen afdekking en plaatst dan de geheugenkaart volgens de afbeelding in de sleuf. Zonder geheugenmedium kunnen geen opnames worden gemaakt.

! Alvorens de micro-SD kaart eruit te nemen moet het apparaat worden uitgeschakeld.

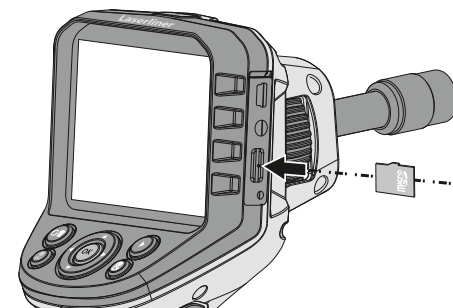

4 Instellingsmodus

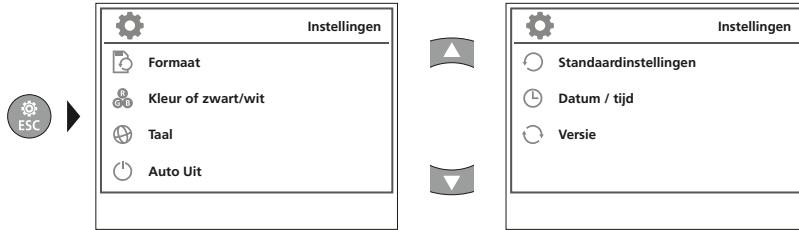

Druk meerdere malen op de ESC-toets om weer naar de opnamemodus te schakelen.

a. Gegevensdrager formatteren

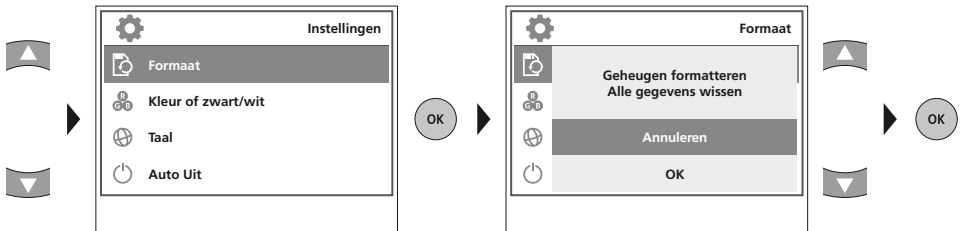

! Alle gegevens op de SD-kaart worden gewist. Dit proces kan niet ongedaan worden gemaakt. Er volgt geen verder verzoek om het wisproces te bevestigen.

b. Kleurenmodus wisselen

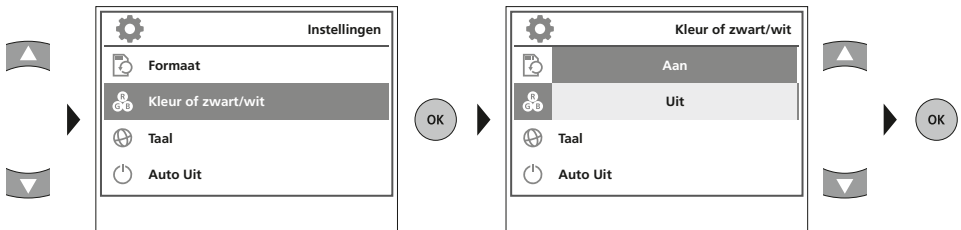

c. Taal wijzigen (EN, JP, FR, DE, IT, PT, NL, ES)

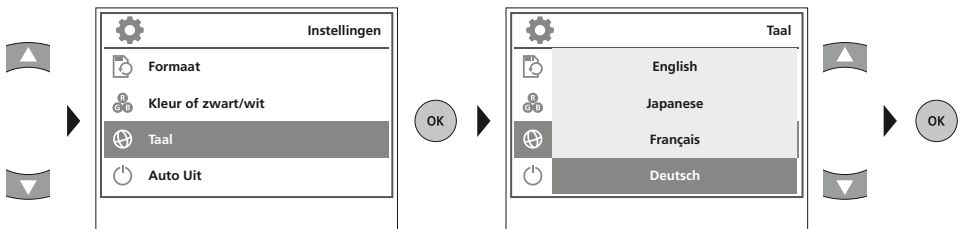

d. Automatische uitschakeling

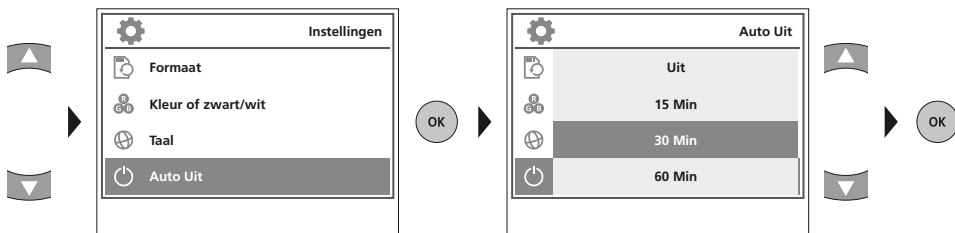

e. Fabrieksinstelling

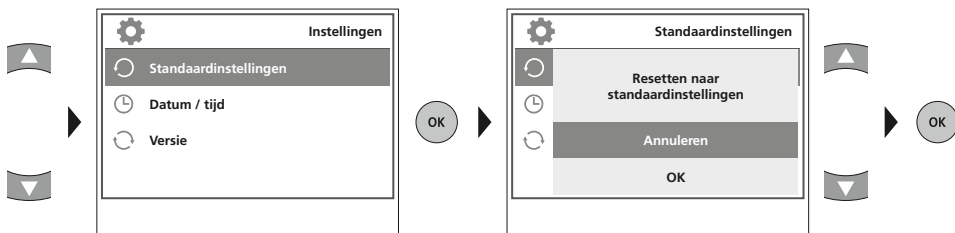

f. Datum / tijd instellen

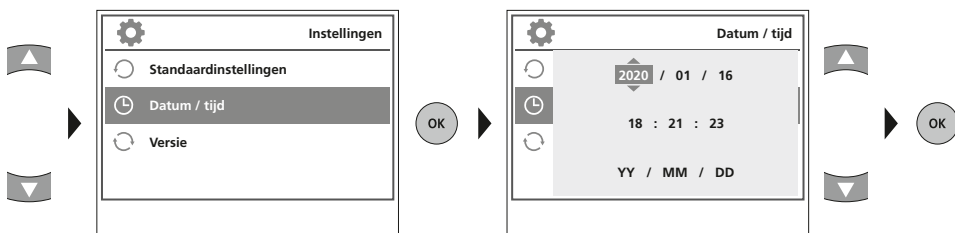

g. Firmware-versie

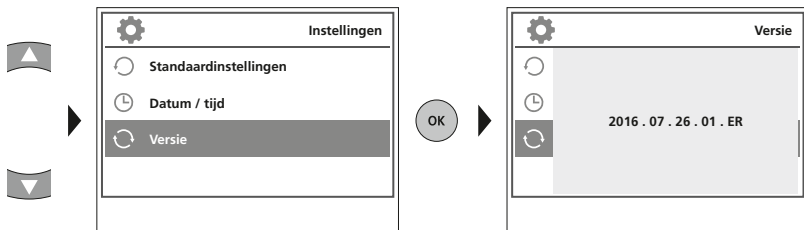

5 Opnamemodus



Foto- / video-opnames

Richt de camerakop aan het uiteinde van de flexibele slang en beweeg hem vervolgens naar de gewenste positie. Schakel de LED-verlichting in geval van slechte lichtomstandigheden in. U kunt kleine objecten of objecten op afstand dichterbij halen (zoomen). Het beeld op de monitor kan met behulp van de beeldrotatie 180° worden gedraaid. Druk kort op de OK-toets om het beeld of de video-opname op te nemen en op de SD-kaart op te slaan. Druk opnieuw op de toets om de opname te stoppen.

a. Omschakeling opname beeld / video

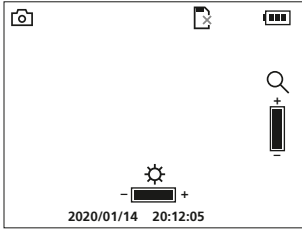
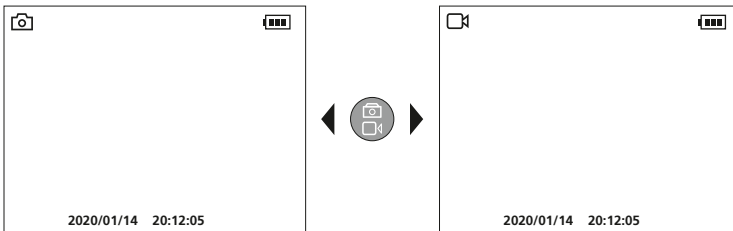

b. LED-verlichting

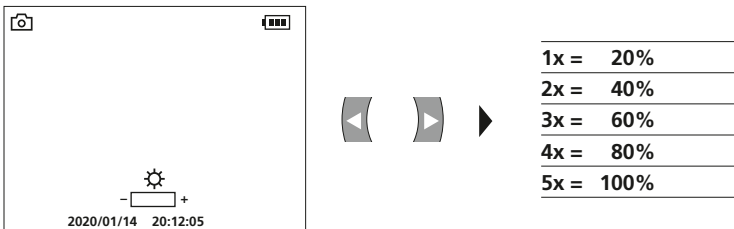

c. Zoom

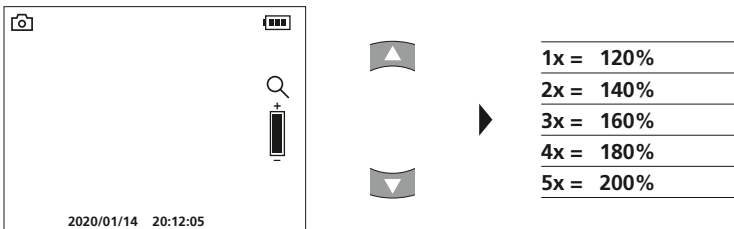

d. Beeldrotatie / Spiegeling

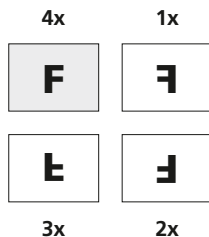
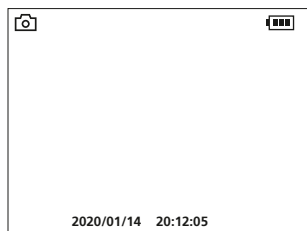

Van het uitgangsbild

1x = horizontale spiegeling

2x = Draaiing 180°

3x = verticale spiegeling

4x = Uitgangsbild

e. Beeld opnemen

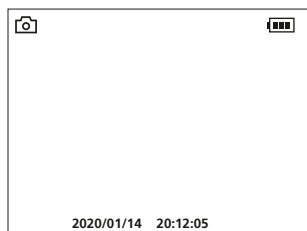

f. Video-opname starten / stoppen

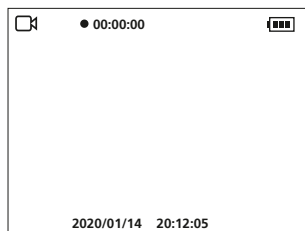
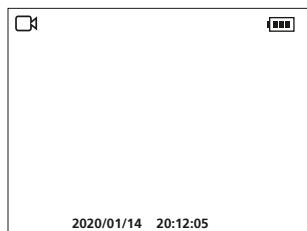

6 Handmatige beelduitlijning

met vaste camera-eenheid

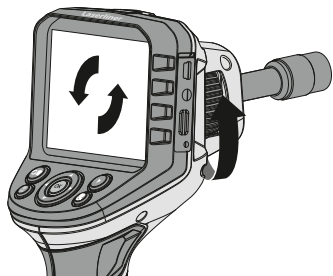

met flexibele camera-eenheid

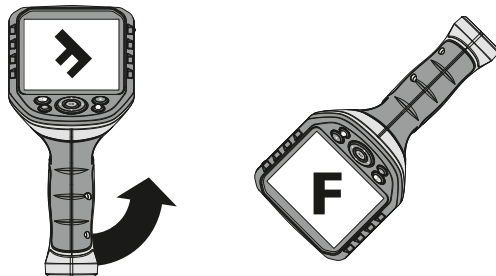

7 Weergavemodus

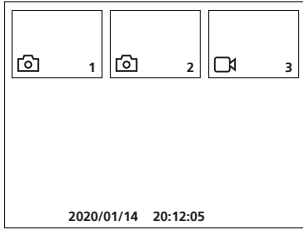

Weergave van foto- / video-opnames

Druk op de toets ,e' om de mediagalerij op te roepen. Bevestig met ,OK' om het geselecteerde beeld of de video op het volledige beeldscherm weer te geven. Met behulp van de pijltoetsen kunt u in de mediagalerij en in de volledige beeldschermweergave navigeren. Door indrukken van toets ,f' wordt de weergavemodus gesloten.

a. Navigeren

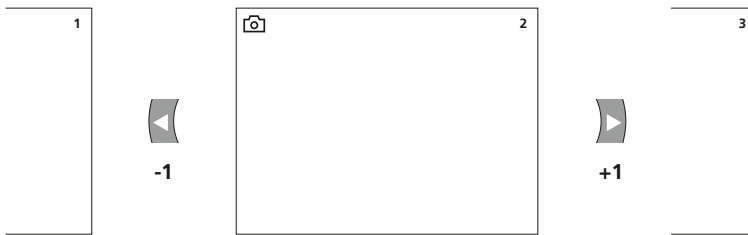

b. Opname wissen

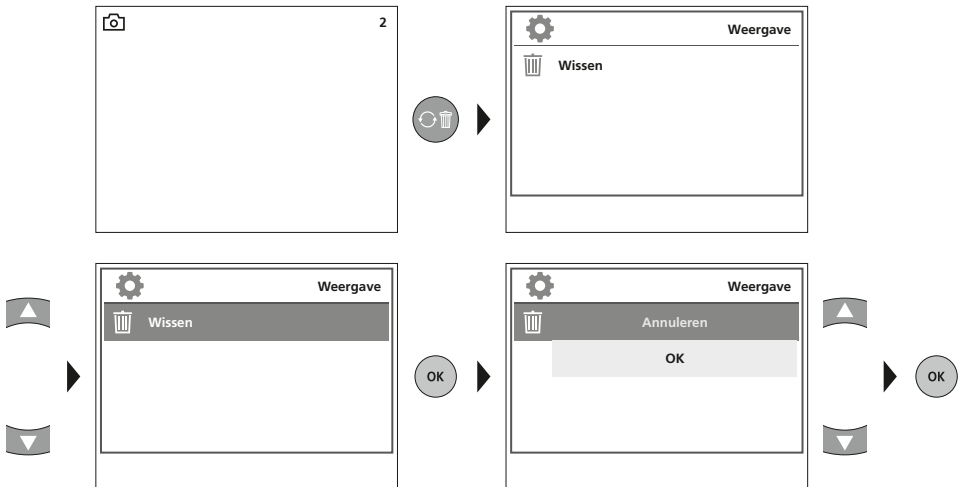

Opnames kunnen alleen in de volledige beeldschermweergave worden gewist. Het wisproces kan niet ongedaan worden gemaakt.



Via de formattering van de gegevensdrager kunnen alle bestanden en mappen worden gewist. Zie hiervoor punt ,4 a. Gegevensdrager formatteren'.

c. Weergave

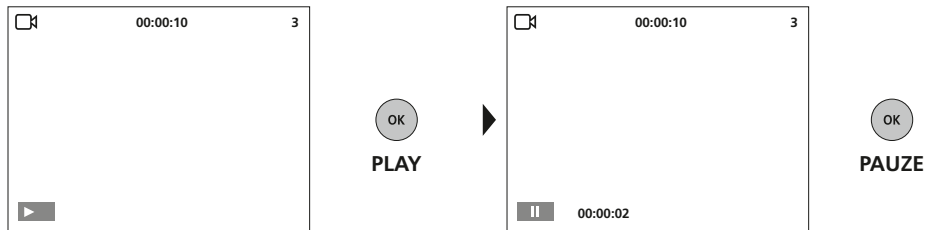

Druk op de toets ‚ESC‘ om de weergave te stoppen.

USB-gegevensoverdracht

De opgeslagen gegevens op de SD-kaart kunnen met een geschikte kaartlezer of direct via de USB-interface naar de pc worden overgedragen. Informatie over de verbinding tussen de computer en de kaartadapter resp. de kaartlezer vindt u in de gebruiksaanwijzing voor uw kaartlezer.

Net-/laadtoestel aansluiten

Sluit om het apparaat op te laden het bijgeleverde net-/laadtoestel aan op de interface USB type C ‚4‘ en verbind deze met een geschikte stroombron.

Technische gegevens

Technische wijzigingen voorbehouden. 21 W09

Beeldschermtype	3,5" TFT-kleurendisplay
Resolutie display	320 x 240 pixel
Resolutie foto / video	640 x 480 pixel
Fotoformaat / videoformaat	JPEG / AVI
Geheugen	Micro-SD geheugenkaart tot 16 GB
Aansluitingen	USB type C, video-uitgang Cinch
Voeding	Li-ion accupak 3,7V / 2,8Ah
Bedrijfsduur	ca. 5 uur
Werkomstandigheden	0°C ... 45°C, luchtvochtigheid max. 20 ... 85% rH, niet-condenserend, werkhoogte max. 4000 m boven NAP (Nieuw Amsterdams Peil)
Opslagvoorwaarden	-10°C ... 60°C, luchtvochtigheid max. 80% rH
Afmetingen (B x H x D)	181 x 207 x 96 mm
Gewicht	342 g (incl. accupak)

EU-bepalingen en afvoer

Het apparaat voldoet aan alle van toepassing zijnde normen voor het vrije goederenverkeer binnen de EU.

Dit product is een elektrisch apparaat en moet volgens de Europese richtlijn voor oude elektrische en elektronische apparatuur gescheiden verzameld en afgevoerd worden.

Verdere veiligheids- en aanvullende instructies onder:

<http://laserliner.com/info?an=AGG>

CE





! Du bedes venligst læse betjeningsvejledningen, det vedlagte hæfte „Garanti- og supplerende anvisninger“ samt de aktuelle oplysninger og henvisninger på internetlinket i slutning af denne vejledning fuldstændigt igennem. Følg de heri indeholdte instrukser. Dette dokument skal opbevares og følge med apparatet, hvis dette overdrages til en ny ejer.

Funktion / anvendelse

Det professionelle videoinspektionssystem VideoFlex G4 er, i kombination med en udskiftelig kameraenhed, egnet til nem visuel kontrol af vanskeligt tilgængelige steder i rør, hulrum, skakter, murværk og køretøjer. Til evaluering og dokumentation kan billederne og videoerne gemmes på SDHC-hukommelseskortet.

Almindelige sikkerhedshenvisninger

- Apparatet må kun bruges til det tiltænkte anvendelsesformål inden for de givne specifikationer.
- Måleapparaterne og tilbehøret er ikke legetøj. Skal opbevares utilgængeligt for børn.
- Konstruktionsmæssigt må apparatet ikke ændres.
- Undgå at udsætte apparatet for mekaniske belastninger, meget høje temperaturer, fugt eller kraftige vibrationer.
- Apparatet må ikke anvendes længere, hvis en eller flere funktioner svigter, eller hvis batteriladningen er svag.
- Ved udendørs brug må udstyret kun anvendes under passende vejrforhold og/eller ved brug af egnede beskyttelsesforanstaltninger.
- Lysdiodeenheden må ikke dyppes ned i vand. Basisapparatet må ikke komme i kontakt med væske.
- Det er vigtigt, at man sørger for, at VideoFlex G4 ikke kommer i kontakt med kemikalier, spænding, bevægelige eller varme genstande. Dette kan ødelægge apparatet og desuden medføre alvorlige personskader på operatøren.
- VideoFlex G4 må ikke anvendes til medicinske undersøgelser/personundersøgelser.
- Iagttag sikkerhedsforanstaltningerne fra lokale og/eller nationale myndigheder med henblik på saglig korrekt brug af apparatet.
- Apparatet er ikke beregnet til måling i nærheden af farlig spænding. Derfor skal man altid sikre sig, at der ikke er spænding i ledende dele, når man foretager målinger i nærheden af elektriske anlæg. Den spændingsfri tilstand og sikring mod genstart skal sikres med passende foranstaltninger.

Sikkerhedsanvisninger

Omgang med elektromagnetisk stråling

- Måleapparatet overholder forskrifterne og grænseværdierne for elektromagnetisk kompatibilitet iht. EMC-direktiv 2014/30/EU.
- Lokale anvendelsesrestriktioner, f.eks. på hospitaler, i fly eller i nærheden af personer med pacemaker, skal iagttages. Risikoen for farlig påvirkning eller fejl i eller pga. elektronisk udstyr er til stede.

Anmærkninger vedr. vedligeholdelse og pleje

Alle komponenter skal rengøres med en let fugtet klud, og man skal undlade brug af rengørings-, skure- og opløsningsmidler. Batterierne skal tages ud inden længere opbevaringsperioder. Apparatet skal opbevares på et rent og tørt sted.

Laserliner

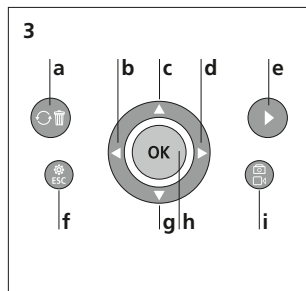
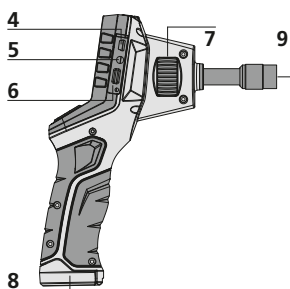
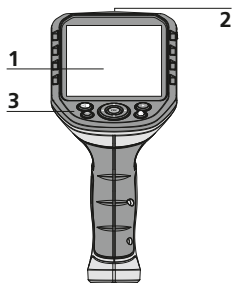

- 1 LC-display
- 2 ON/OFF
- 3 Direkt-knapper
- 4 Grænseflade USB type C
- 5 Videoudgang
- 6 Port til SD-kort
- 7 Drejhjul kameraenhed
- 8 Batterirum
- 9 Tilslutning kameraenhed

- a Rotation 180° / Spejling / Slet optagelser
- b Menustyring / Diodelampe –
- c Menustyring / + Zoom
- d Menustyring / Diodelampe +
- e Mediegalleri

- f Indstillingsmodus / Afbryd
- g Menustyring / – Zoom
- h Udløser / Optagelse / Bekræft
- i Omstilling billede / video

Optagelsesmodus billede

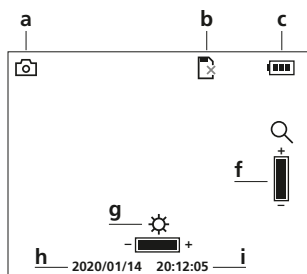

Optagelsesmodus video

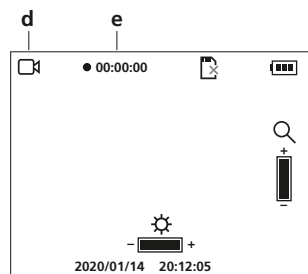

- a Optagelse billede
- b Indsæt SD-kort
- c Batteristatus
- d Optagelse video
- e REC: Optagelse i gang
- f Zoom
- g Diodelampe
- h Aktuel dato
- i Aktuelt klokkeslæt

Gengivelsesmodus billede

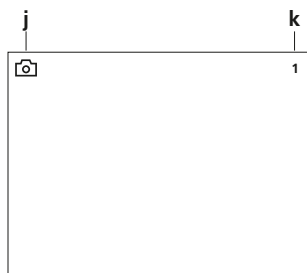



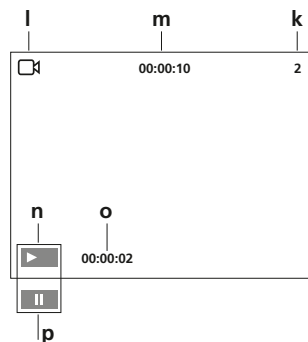





Gengivelsesmodus video



- j Optagelse billede
- k Nummer på optagelse
- l Optagelse video
- m Optagelsestid
- n Play
- o Afspillet tid
- p Pause

Indstillingsmodus

Indstillinger	
	
 Format	— q
 Farve eller sort/hvid	— r
 Sprog	— s
 Auto Fra	— t

Indstillinger	
 Standardindstillinger	— u
 Dato/klokkeslæt	— v
 Version	— w

- q** Formatér datamedium
- r** Skift farvemodus
- s** Skift sprog
(EN, JP, FR, DE, IT, PT, NL, ES)
- t** Automatische Abschaltung
- u** Fabriksindstilling
- v** Indstilling af dato/klokkeslæt
- w** Firmware-version

Idriftsættelse

1 Tilslutning flexslange

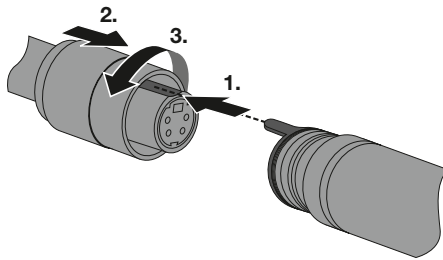

2 ON/OFF

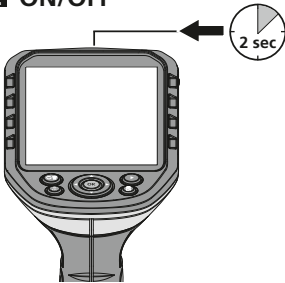

RESET

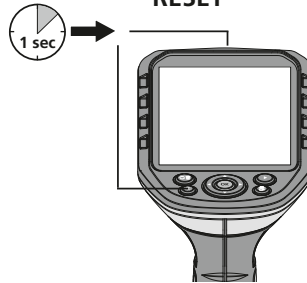

3 Indsæt mikro-SD-kort

Man indsætter et mikro-SD-kort ved først at åbne gummiafdækningen og dernæst indsætte hukommelseskortet som vist i figuren. Uden hukommelsesmedium kan optagelser ikke gemmes.

! Inden mikro-SD-kortet tages ud, skal apparatet slukkes.

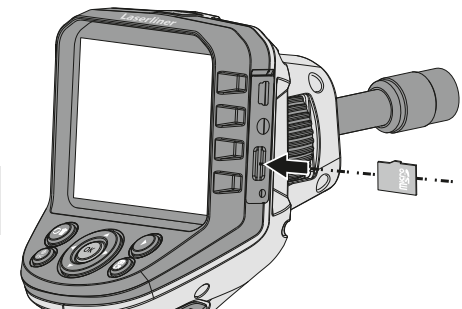

4 Indstillingsmodus

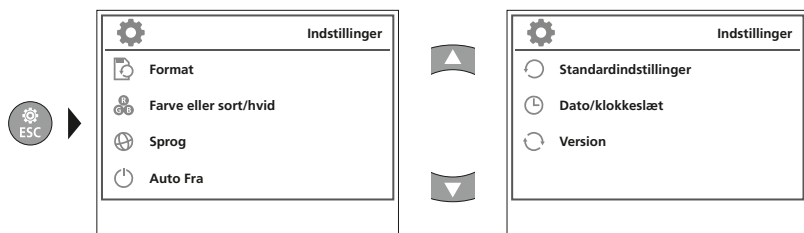

Man kommer tilbage til optagelsesmodus ved at trykke gentagne gange på knappen ESC.

a. Formater datamedium

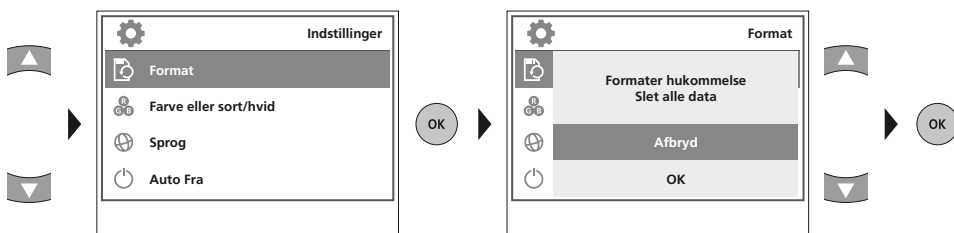

! Alle data på SD-kortet slettes. Denne proces kan ikke fortrydes. Der bedes ikke om yderligere bekræftelse af processen.

b. Skift farvemodus

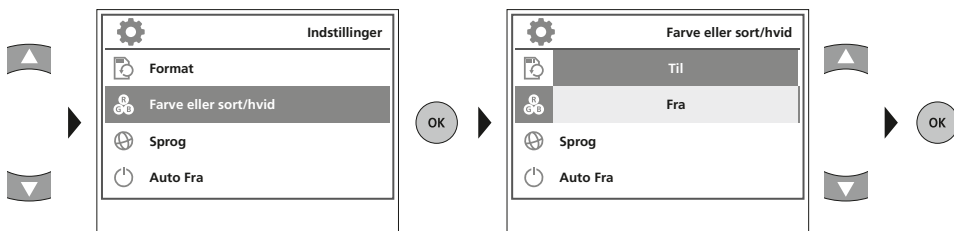

c. Skift sprog (EN, JP, FR, DE, IT, PT, NL, ES)

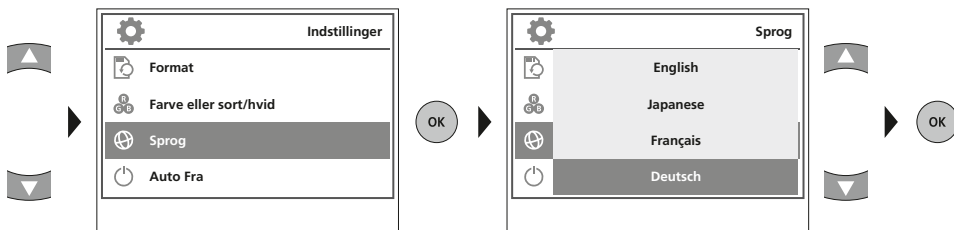

d. Automatisk slukning

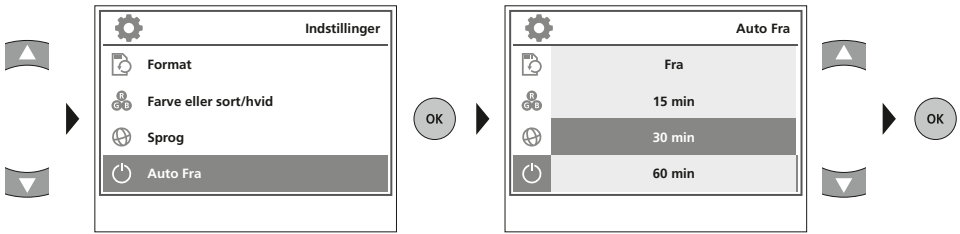

e. Fabriksindstilling

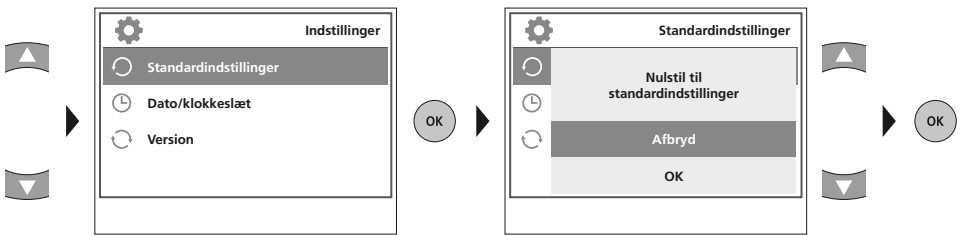

f. Indstilling af dato/klokkeslæt

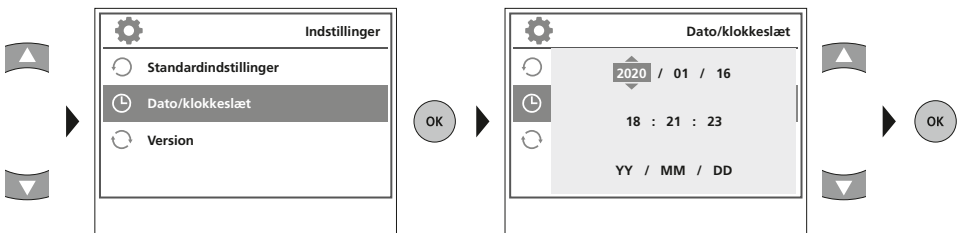

g. Firmware-Version

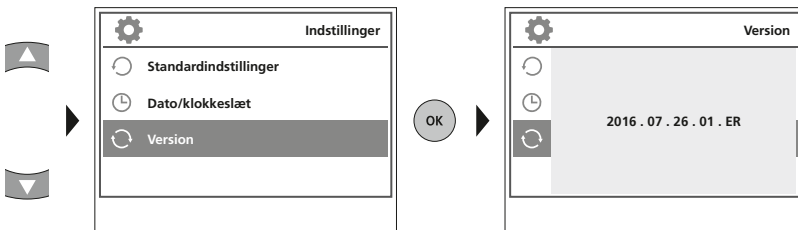

5 Optagelsesmodus

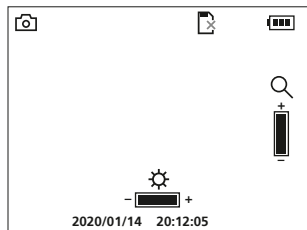

Billed-/videoptagelse

Man indstiller kamerahovedet på flexslangen og fører det hen til den ønskede position. Under dårlige lysforhold kan man tænde diodelampen. Man kan zoome ind på fjerne eller små objekter. Via den manuelle billedrotation kan billedet roteres 180° på skærmen. Når man trykker kortvarigt på OK-knappen, optages billedet eller videoen og gemmes på SD-kortet. Optagelsen afsluttes ved at trykke på tasten igen.

a. Skift mellem billede/video

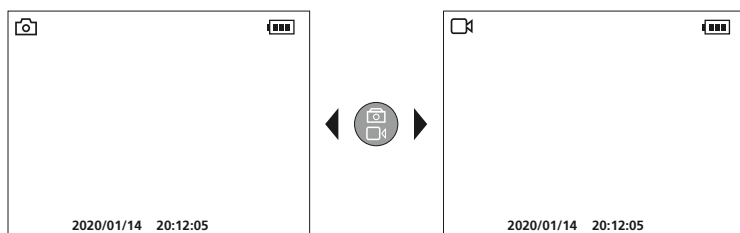

b. Diodelampe

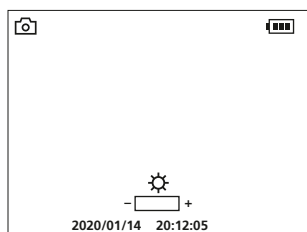

1x = 20%

2x = 40%

3x = 60%

4x = 80%

5x = 100%

c. Zoom

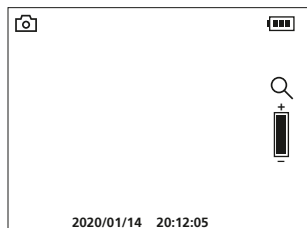

1x = 120%

2x = 140%

3x = 160%

4x = 180%

5x = 200%

d. Billedrotation / Spejling

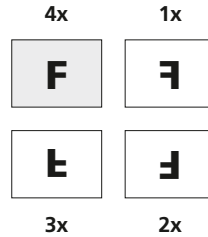
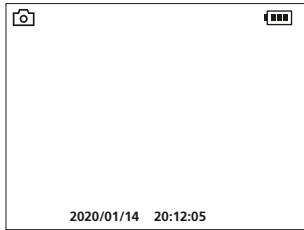

Fra udgangsbilledet

1x = horisontal spejling

2x = Drejning 180°

3x = vertikal spejling

4x = Udgangsbillede

e. Optag billede

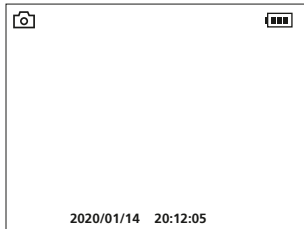

f. Start / afslut videooptagelse

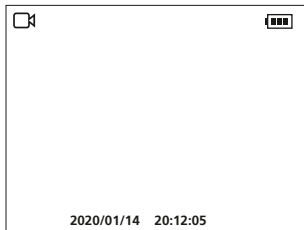

START

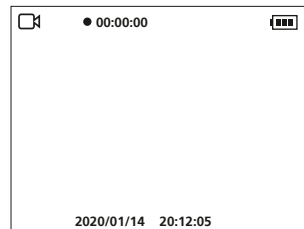

STOP

6 Manuel billedjustering

med stiv kameraenhed

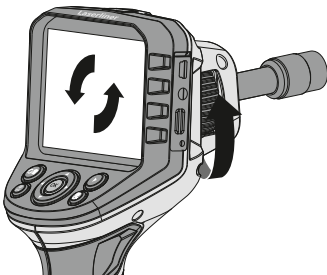

med fleksibel kameraenhed

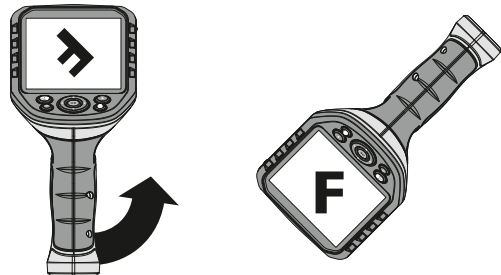

7 Gengivelsesmodus

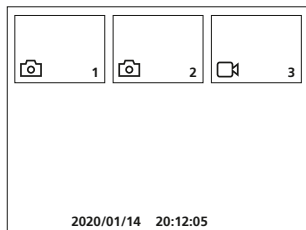

Gengivelse af billed-/videoptagelser

Når man trykker på knappen „e“, indhentes mediegalleriet. Bekræft med „OK“ for at få vist det valgte billede eller video i fuld skærmmodus. Man kan bruge piletasterne til at navigere i mediegalleriet og i fuld skærmmodus. Ved at trykke på knappen „f“, lukkes gengivelsesmodus.

a. Navigering

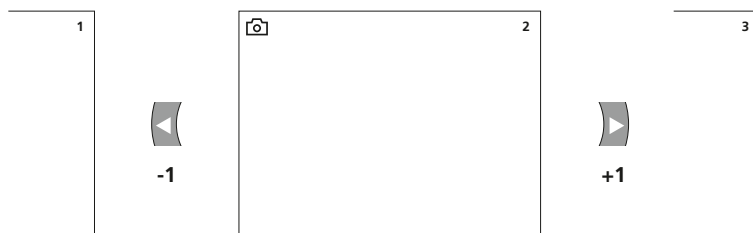

b. Slet optagelse

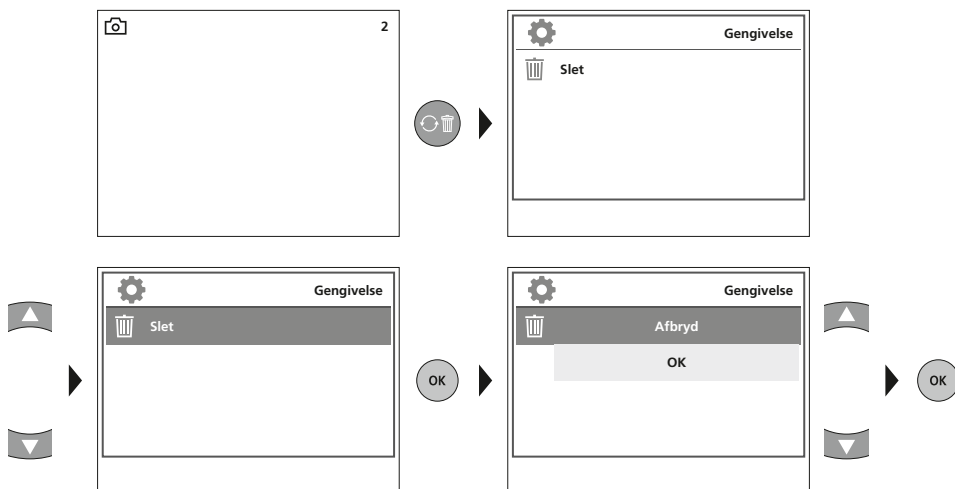

! Optagelser kan kun slettes i fuld skærmmodus. Sletteprocessen kan ikke fortrydes.

! Via formatering af datamedierne kan man slette alle filer og mapper. Se punkt „4 a. Formater datamedium“.

c. Gengivelse

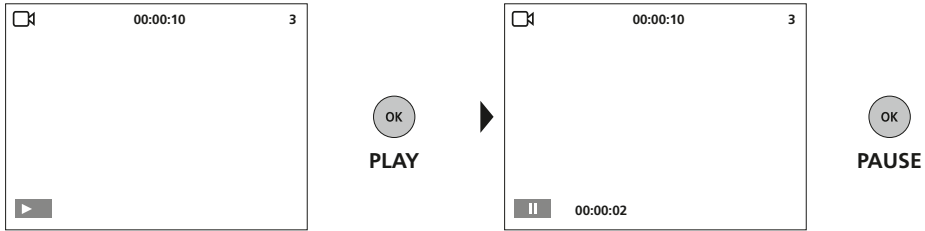

Når man trykker på knappen ESC, stoppes gengivelsen.

USB-dataoverførsel

De lagrede data på SD-kortet kan overføres til pc'en enten med en passende kortlæser eller direkte via USB-interfacet. Oplysninger om forbindelse mellem computer og kort-adapter eller kortlæser findes i manualen til kortlæseren.

Tilslutning af lysnetoplader

Når udstyret skal oplades, tilsluttes den medfølgende strømforsyningsenhed/oplader til grænsefladen, USB type C „4“, og forbindes med en passende strømkilde.

Tekniske data		Forbehold for tekniske ændringer. 21W09
Skærmtype	3,5" TFT-farvedisplay	
Opløsning display	320 x 240 pixel	
Opløsning billede / video	640 x 480 pixel	
Billedformat / videoformat	JPEG / AVI	
Hukommelse	Mikro-SD-kort op til 16 GB	
Tilslutninger	USB type C, video-udgang cinch	
Strømforsyning	Li-ion-batteripakke 3,7V / 2,8Ah	
Driftstid	ca. 5 timer	
Arbejdsbetingelser	0°C ... 45°C, luftfugtighed maks. 20 ... 85% rH, ikke-kondenserende, arbejds højde maks. 4000 m.o.h.	
Opbevaringsbetingelser	-10°C ... 60°C, luftfugtighed maks. 80% rH	
Mål (B x H x D)	181 x 207 x 96 mm	
Vægt	342 g (inkl. batteri)	

EU-bestemmelser og bortskaffelse

Apparatet opfylder alle påkrævede standarder for fri vareomsætning inden for EU.

Dette produkt er et elapparat og skal indsamles og bortskaffes separat i henhold til EF-direktivet for (brugte) elapparater.

Flere sikkerhedsanvisninger og supplerende tips på:

<http://laserliner.com/info?an=AGG>



! Lisez entièrement le mode d'emploi, le carnet ci-joint « Remarques supplémentaires et concernant la garantie » et les renseignements et consignes présentés sur le lien Internet précisé à la fin de ces instructions. Suivez les instructions mentionnées ici. Conservez ces informations et les donner à la personne à laquelle vous remettez l'instrument.

Fonction / Utilisation

Combiné avec une unité de caméra interchangeable, le système professionnel d'inspection vidéo VideoFlex G4 facilite le contrôle visuel d'emplacements difficiles d'accès dans les tuyaux, les cavités, les puits, la maçonnerie et les véhicules automobiles. Il est possible d'enregistrer les photos et les vidéos sur la carte mémoire SDHC pour l'analyse et la documentation.

Consignes de sécurité générales

- Utiliser uniquement l'instrument pour l'emploi prévu dans le cadre des spécifications.
- Les appareils et les accessoires ne sont pas des jouets. Les ranger hors de portée des enfants.
- Il est interdit de modifier la construction de l'instrument.
- Ne pas soumettre l'appareil à une charge mécanique, ni à des températures extrêmes ni à de l'humidité ou à des vibrations importantes.
- Ne plus utiliser l'instrument lorsqu'une ou plusieurs fonction(s) ne fonctionne(nt) plus ou lorsque le niveau de charge de la pile est bas.
- Faire attention lors de l'utilisation à l'extérieur à n'utiliser l'appareil que dans les conditions météorologiques adéquates et/ou en prenant les mesures de sécurité appropriées.
- Ne pas plonger l'écran ACL dans l'eau. L'appareil de base ne doit pas entrer en contact avec des liquides.
- Il est indispensable de faire attention à ce que le VideoFlex G4 n'entre pas en contact avec des produits chimiques, du tension électrique ou encore des pièces brûlantes ou en mouvement. Cela peut endommager l'appareil et provoquer de graves blessures chez l'utilisateur.
- Il est interdit d'utiliser le VideoFlex G4 pour des examens médicaux/effectués sur des personnes.
- Prière de tenir compte des mesures de sécurité de l'administration locale et/ou nationale relative à l'utilisation correcte de l'appareil.
- L'appareil ne convient pas à la mesure à proximité d'une tension dangereuse. C'est pourquoi, il faut toujours faire attention à l'absence de tension des pièces conductrices en cas de mesures à proximité d'installations électriques. Garantir l'absence de tension et l'impossibilité de toute remise sous tension en prenant les mesures nécessaires.

Consignes de sécurité

Comportement à adopter lors de rayonnements électromagnétiques

- L'appareil de mesure respecte les prescriptions et les valeurs limites de compatibilité électromagnétique conformément à la directive CEM 2014/30/UE.
- Il faut tenir compte des restrictions des activités par ex. dans les hôpitaux, les avions, les stations-services ou à proximité de personnes portant un stimulateur cardiaque. Les appareils électroniques peuvent être la source ou faire l'objet de risques ou de perturbations.

Remarques concernant la maintenance et l'entretien

Nettoyer tous les composants avec un chiffon légèrement humide et éviter d'utiliser des produits de nettoyage, des produits à récurer ou des solvants. Retirer la/les pile(s) avant tout stockage prolongé de l'appareil. Stocker l'appareil à un endroit sec et propre.

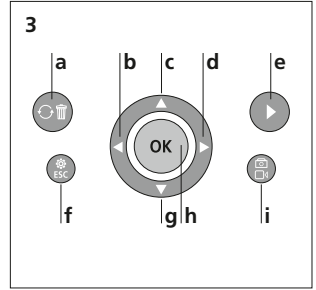
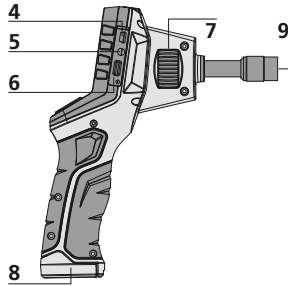
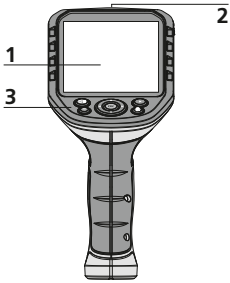

- 1 Affichage à cristaux liquides
- 2 ON/OFF
- 3 Touches directes
- 4 Interface USB de type C
- 5 Sortie vidéo
- 6 Slot carte Micro-SD
- 7 Molette de l'unité de caméra
- 8 Compartiment à accu
- 9 Raccord de l'unité de caméra

- a Rotation 180° / Réflexion / Effacer les enregistrements
- b Commande des menus / Éclairage DEL -
- c Commande des menus / Zoom +
- d Commande des menus / Éclairage DEL +
- e Galerie média

- f Mode de réglage / Annuler
- g Commande des menus / Zoom -
- h Déclencheur / Enregistrement / Validation
- i Commutation image / vidéo

Mode d'enregistrement image

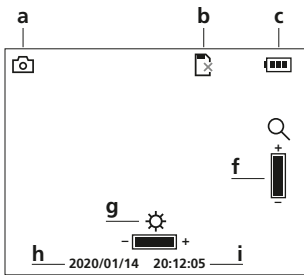

Mode d'enregistrement vidéo

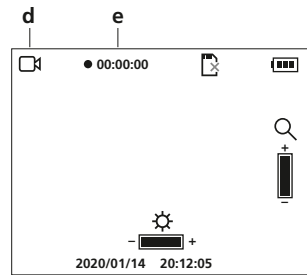

- a Enregistrement photo
- b Introduire la carte SD
- c État de charge des piles
- d Enregistrement vidéo
- e REC : Enregistrement en cours
- f Zoom
- g Éclairage DEL
- h Date actuelle
- i Heure actuelle

Mode de lecture image

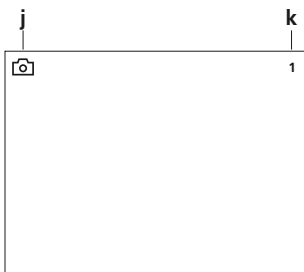



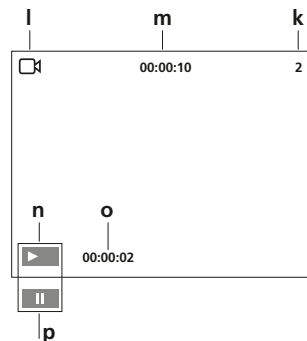



Mode de lecture vidéo



- j Enregistrement photo
- k Numéro de l'enregistrement
- l Enregistrement vidéo
- m Date d'enregistrement
- n Lecture
- o durée lue
- p Pause

Mode de réglage

Réglages	
 Format	— q
 Couleurs ou noir / blanc	— r
 Langue	— s
 Auto éteint	— t

Réglages	
 Régles standard	— u
 Date/Heure	— v
 Version	— w

- q** Formater support de données
- r** Changer le mode couleur
- s** Changer la langue (EN, JP, FR, DE, IT, PT, NL, ES)
- t** Arrêt automatique
- u** Réglage usine
- v** Réglage date/heure
- w** Version du micrologiciel

Mise en service

1 Raccord du tuyau flexible

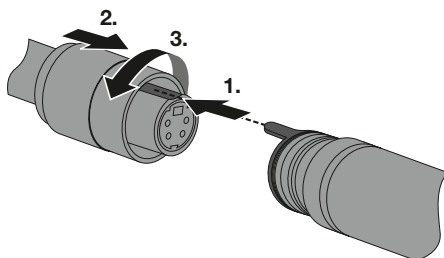

2 ON/OFF

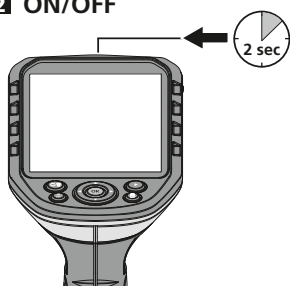

REMISE À ZÉRO

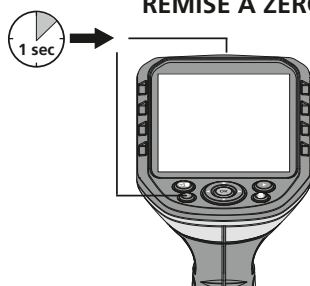

3 Introduction de la micro carte SD

Pour introduire une micro carte SD, ouvrez tout d'abord le couvercle en caoutchouc, puis placez la carte de mémoire comme illustrée. Aucun enregistrement n'est possible sans support de mémorisation.

! L'appareil doit être éteint avant de retirer la carte micro SD.

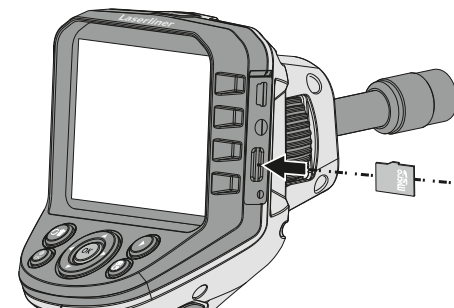

4 Mode de réglage

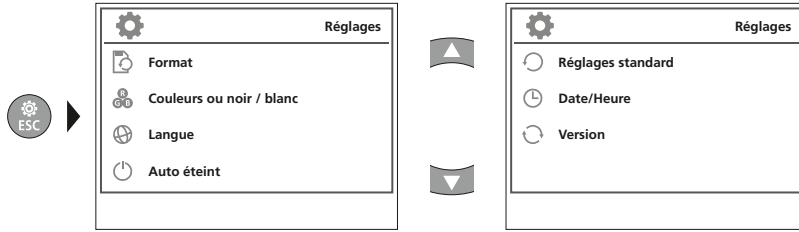

Pour revenir au mode d'enregistrement, il faut appuyer plusieurs fois sur la touche ESC.

a. Formater support de données

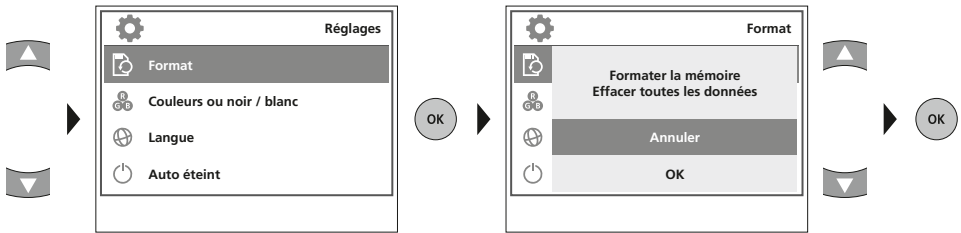

! Toutes les données de la carte SD seront supprimées. Cette opération ne peut pas être annulée. Il n'y a aucune autre demande de confirmation du processus.

b. Changer le mode couleur

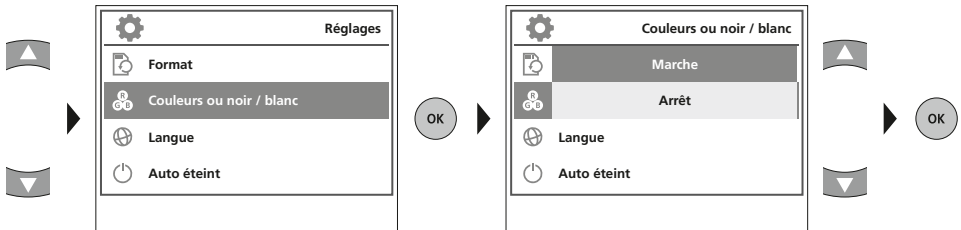

c. Changer la langue (EN, JP, FR, DE, IT, PT, NL, ES)

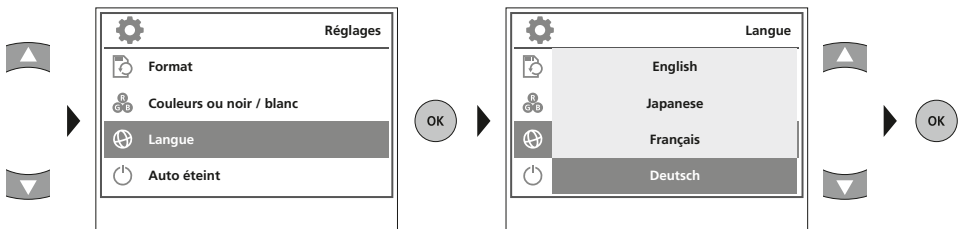

d. Arrêt automatique

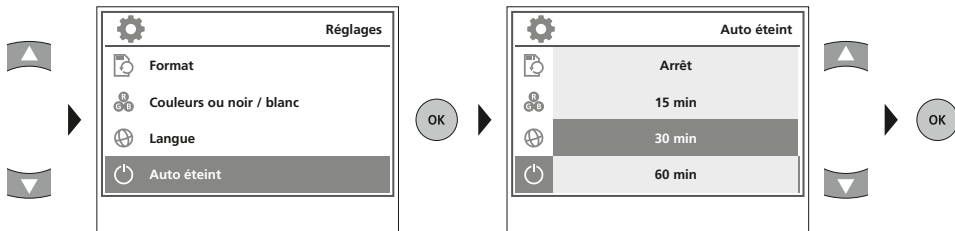

e. Réglage usine

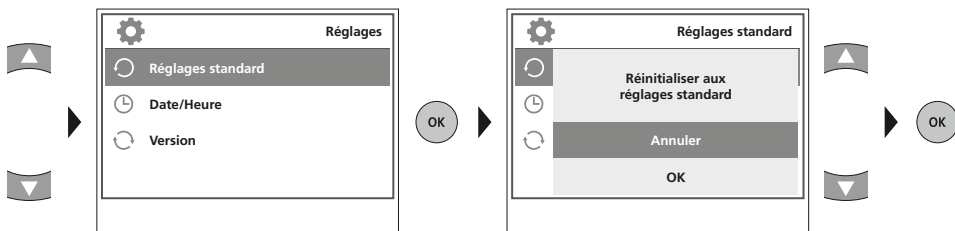

f. Réglage date/heure

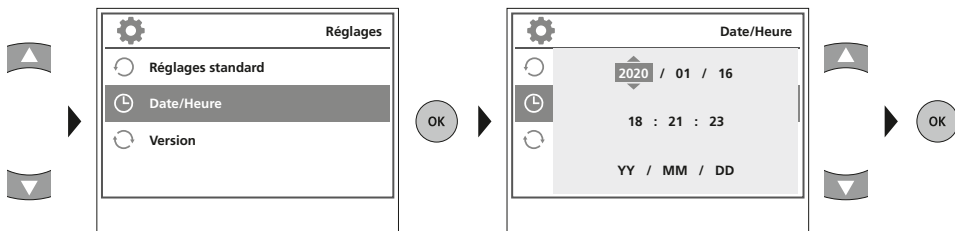

g. Version du micrologiciel

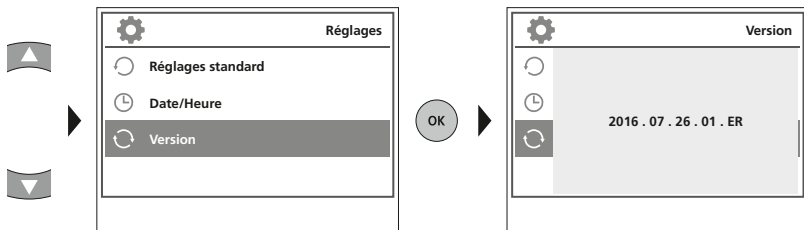

5 Mode d'enregistrement

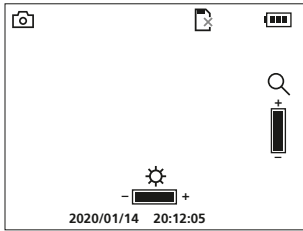

Enregistrement d'images/vidéo

Orienter la tête de la caméra au niveau du tuyau flexible et la mettre à la position souhaitée. Activer l'éclairage DEL en cas de mauvaise visibilité. Zoomer sur des objets de petite taille ou éloignés. La rotation manuelle des images permet de faire tourner l'image de 180° sur le moniteur. Actionner brièvement la touche OK pour enregistrer la photo ou l'enregistrement vidéo et le mémoriser sur la carte SD. Un nouvel actionnement met fin à l'enregistrement.

a. Commutation enregistrement image/vidéo

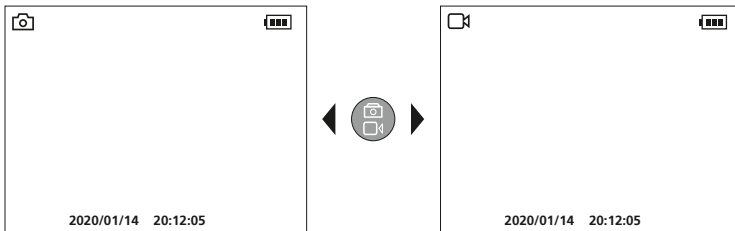

b. Éclairage DEL

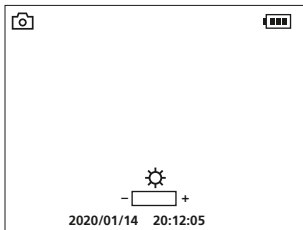

1x =	20%
2x =	40%
3x =	60%
4x =	80%
5x =	100%

c. Zoom

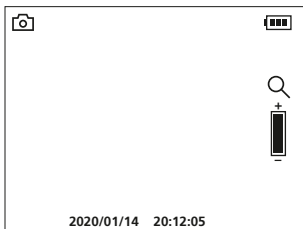

1x =	120%
2x =	140%
3x =	160%
4x =	180%
5x =	200%

d. Rotation de l'image / Réflexion

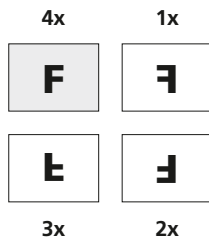
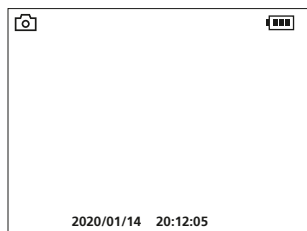

À partir de l'image initiale

1x = Réflexion horizontale

2x = Rotation de 180°

3x = Réflexion verticale

4x = Image initiale

e. Enregistrer image

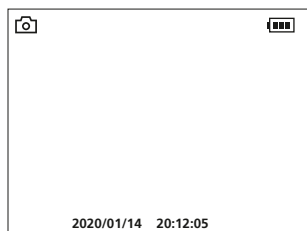

f. Démarrer / arrêter un enregistrement vidéo

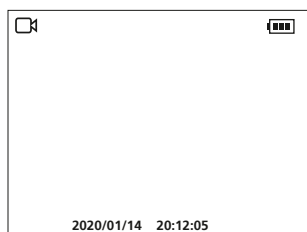

DÉMARRER

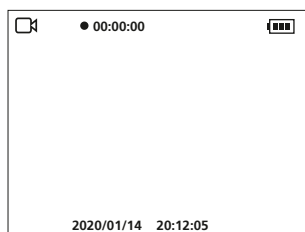

ARRÊTER

6 Orientation manuelle de l'image

avec une unité de caméra fixe

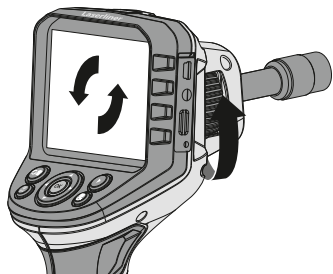

avec une unité de caméra flexible

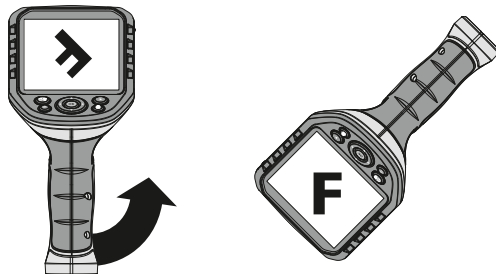

7 Mode de reproduction

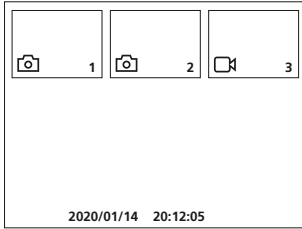

Reproduction d'images / d'enregistrement vidéo

Appuyer sur la touche « e » pour sélectionner la galerie média. En validant avec « OK », la photo ou la vidéo sélectionnée s'affiche en mode plein écran. Il est possible de naviguer dans la galerie média et dans le mode plein écran avec les touches fléchées. En appuyant sur la touche « f », le mode lecture est terminé.

a. Navigation

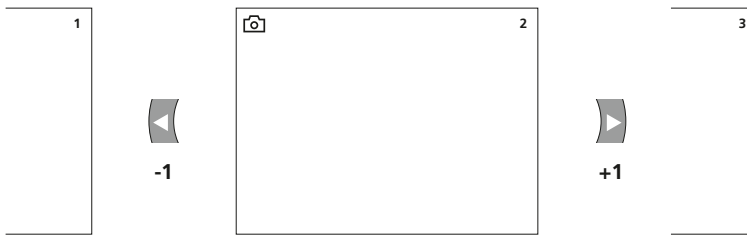

b. Effacer l'enregistrement

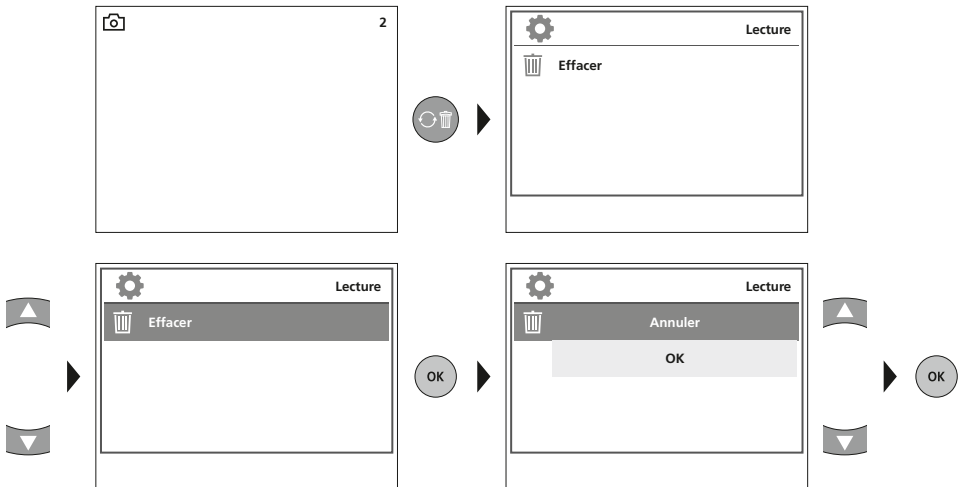

Les enregistrements ne peuvent être supprimés qu'en mode plein écran. Le processus de suppression ne peut pas être annulé.



Le formatage du support de données permet d'effacer tous les fichiers et dossiers. Voir à ce sujet le point « 4 a. Formater le support de données ».

c. Lecture

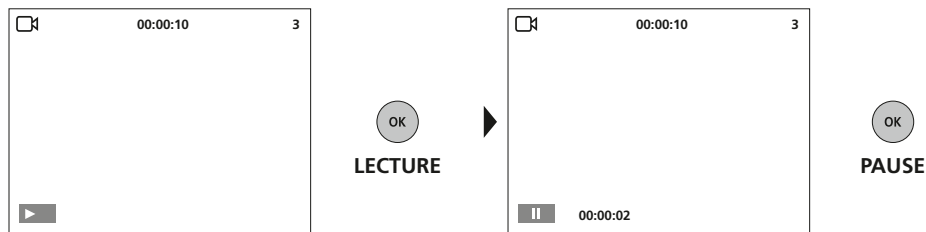

Il suffit d'appuyer sur la touche ESC pour arrêter la lecture.

Transmission des données par USB

Les données mémorisées sur la carte SD peuvent être transmises à un ordinateur soit en utilisant le lecteur de cartes correspondant, soit via l'interface USB. Prière de consulter le manuel relatif au lecteur de cartes pour obtenir de plus amples informations sur la liaison entre l'ordinateur et l'adaptateur de carte ou le lecteur de cartes.

Branchement du bloc secteur/chargeur

Pour recharger l'appareil, connecter le bloc d'alimentation électrique/chargeur fourni avec l'appareil à l'interface USB de type C « 4 » et le raccorder à une source de courant adaptée.

Données techniques

ous réserve de modifications techniques. 21W09

Type de l'écran	Ecran d'affichage TFT de 3,5 po
Résolution de l'écran d'affichage	320 x 240 pixels
Résolution de l'image / la vidéo	640 x 480 pixels
Format de l'image/de la vidéo	JPEG / AVI
Mémoire	Carte mémoire micro SD jusqu'à 16 Go
Connexions	USB de type C, sortie vidéo Cinch
Alimentation électrique	Pack d'accus Li-ions 3,7V / 2,8Ah
Durée de fonctionnement	env. 5 h
Conditions de travail	0°C ... 45°C, humidité relative de l'air max. 20 ... 85% RH, non condensante, altitude de travail max. de 4 000 m au-dessus du niveau moyen de la mer
Conditions de stockage	-10°C ... 60°C, humidité relative de l'air max. 80% RH
Dimensions (L x H x P)	181 x 207 x 96 mm
Poids	342 g (pack d'accu inclus)

Réglementation UE et élimination des déchets

L'appareil est conforme à toutes les normes nécessaires pour la libre circulation des marchandises dans l'Union européenne.

Ce produit est un appareil électrique et doit donc faire l'objet d'une collecte et d'une mise au rebut sélectives conformément à la directive européenne sur les anciens appareils électriques et électroniques (directive DEEE).

Autres remarques complémentaires et consignes de sécurité sur

<http://laserliner.com/info?an=AGG>



! Lea atentamente las instrucciones y el libro adjunto de «Garantía e información complementaria», así como toda la información e indicaciones en el enlace de Internet indicado al final de estas instrucciones. Siga las instrucciones indicadas en ellas. Conserve esta documentación y entréguela con el dispositivo si cambia de manos.

Funcionamiento y uso

El sistema profesional de inspección por vídeo VideoFlex G4, combinado con una unidad de cámara intercambiable, es apto para un sencillo control visual de puntos de difícil acceso en tuberías, espacios huecos, pozos, muros o vehículos. Para el análisis y la documentación se puede guardar las tomas de imágenes y vídeos en la tarjeta de memoria SDHC.

Indicaciones generales de seguridad

- Utilice el aparato únicamente para los usos previstos dentro de las especificaciones.
- Los instrumentos de medición y los accesorios no son juguetes infantiles. Manténgalos fuera del alcance de los niños.
- No está permitido modificar la construcción del aparato.
- No exponga el aparato a cargas mecánicas, temperaturas muy elevadas, humedad o vibraciones fuertes.
- No se puede seguir utilizando el aparato cuando falla alguna función o la carga de la batería es débil.
- Cuando utilice el aparato al aire libre procure que sea usado bajo las condiciones meteorológicas adecuadas o con las medidas de protección correspondientes.
- No se puede sumergir la unidad LCD en agua. El aparato básico no debe estar en contacto con líquidos.
- Es indispensable evitar que la VideoFlex G4 entre en contacto con sustancias químicas, voltaje eléctrico, objetos móviles o calientes. Esto podría provocar daños en el aparato y causar lesiones graves al usuario.
- No se puede utilizar la VideoFlex G4 para realizar exámenes médicos o exploraciones en personas.
- Por favor respete las medidas de seguridad dispuestas por las autoridades locales o nacionales en relación al uso adecuado del aparato.
- El aparato no es apto para realizar mediciones cerca de tensión peligrosa. Por esa razón, las mediciones cerca de instalaciones eléctricas deberán ser realizadas con las piezas conductoras sin tensión. La ausencia de tensión y el seguro contra la conexión de nuevo tienen que estar garantizados por las medidas adecuadas.

Instrucciones de seguridad

Manejo de radiación electromagnética

- El instrumento de medición cumple las normas y limitaciones de compatibilidad electromagnética según la Directiva 2014/30/UE de compatibilidad electromagnética (EMC).
- Es necesario observar las limitaciones de uso locales, por ejemplo en hospitales, aviones, gasolineras o cerca de personas con marcapasos. Se pueden producir efectos peligrosos o interferencias sobre los dispositivos electrónicos o por causa de estos.

Indicaciones sobre el mantenimiento y el cuidado

Limpie todos los componentes con un paño ligeramente humedecido y evite el uso de productos de limpieza, abrasivos y disolventes. Retire la/s pila/s para guardar el aparato por un periodo prolongado. Conserve el aparato en un lugar limpio y seco.

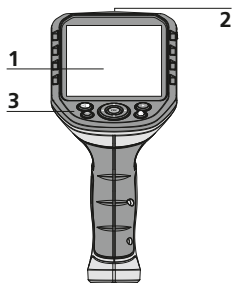

- 1 Pantalla LC
- 2 ON/OFF
- 3 Botones directos

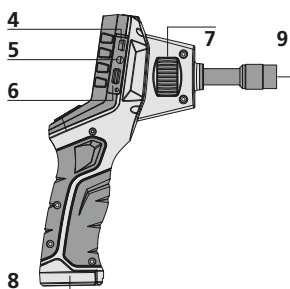

- 4 Puerto USB tipo C
- 5 Salida para vídeo
- 6 Ranura para tarjeta micro-SD
- 7 Rueda de la unidad para la cámara
- 8 Compartimento para pilas
- 9 Conexión de la unidad para la cámara

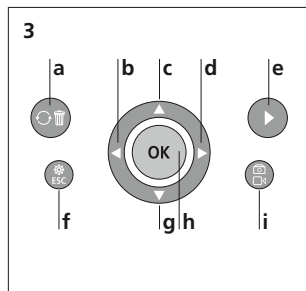

- a Rotation 180° / Simetría / Borrar tomas
- b Control del menú / Iluminación LED -
- c Control del menú / Zoom +
- d Control del menú / Iluminación LED +
- e Galería de medios
- f Modo de configuración / Cancelar
- g Control del menú / Zoom -
- h Disparador / Grabación / Confirmar
- i Cambio entre imagen y vídeo

Modo de toma de imágenes

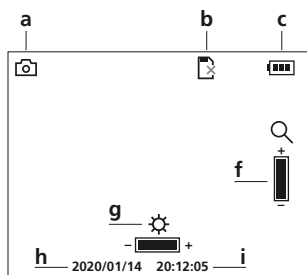

Modo de grabación de vídeos



- a Tomar imagen
- b Introducir tarjeta SD
- c Estado de las pilas
- d Grabar vídeo
- e REC: grabando
- f Zoom
- g Iluminación LED
- h Fecha actual
- i Hora actual

Modo de reproducción de imágenes

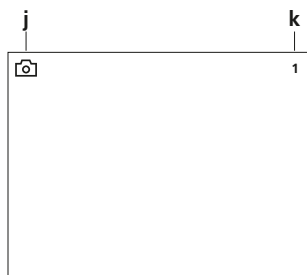

Modo de reproducción de vídeos

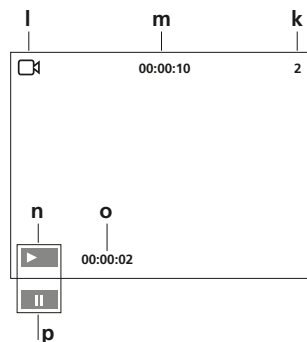

- j Tomar imagen
- k Número de la imagen
- l Grabar vídeo
- m Duración del vídeo
- n Play
- o Duración de las tomas realizadas
- p Pausa

Modo de configuración

Configuración	
	Formato — q
	Color o blanco/negro — r
	Idioma — s
	Auto off — t

Configuración	
	Ajustes estándar — u
	Fecha y hora — v
	Versión — w

- q** Formatear soporte de datos
- r** Cambiar a modo en color
- s** Cambiar idioma (EN, JP, FR, DE, IT, PT, NL, ES)
- t** Parada automática
- u** Configuración original
- v** Ajustar fecha y hora
- w** Versión del Firmware

Puesta en funcionamiento

1 Entrada tubo flexible

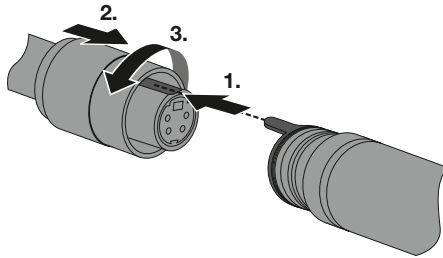

2 ON/OFF

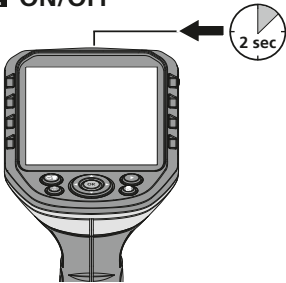

RESET

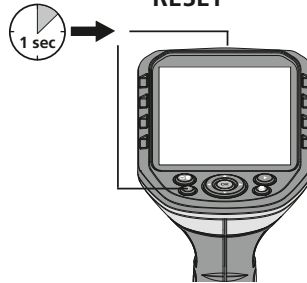

3 Modo de introducir la tarjeta micro-SD

Para colocar la tarjeta Micro-SD abra primero la tapa de goma e introduzca la tarjeta de memoria como se muestra en la imagen. Sin soporte de memoria no es posible realizar ninguna toma ni grabación.

! Antes de retirar la tarjeta micro SD hay que apagar el dispositivo.

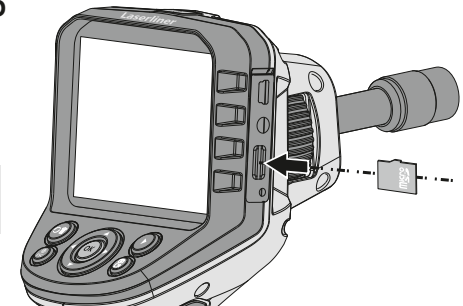

4 Modo de configuración

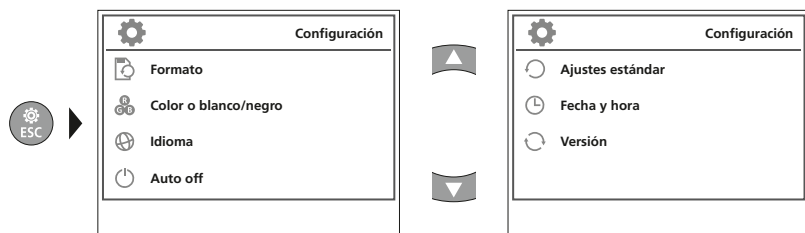

Para cambiar de nuevo al modo de grabación, pulse varias veces la ESC.

a. Formatear soporte de datos

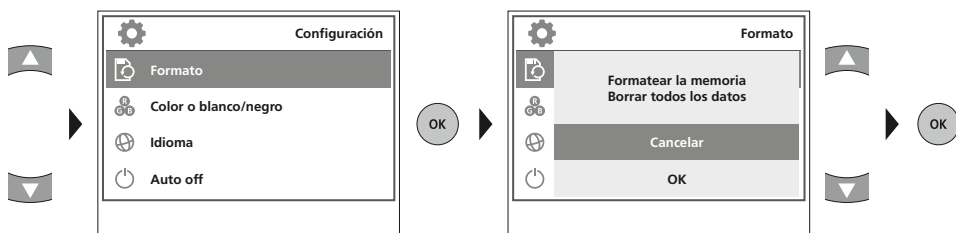

! Se borran todos los datos de la tarjeta SD y no se puede deshacer la operación de borrado. No se demanda ninguna confirmación del proceso de borrado.

b. Cambiar a modo en color

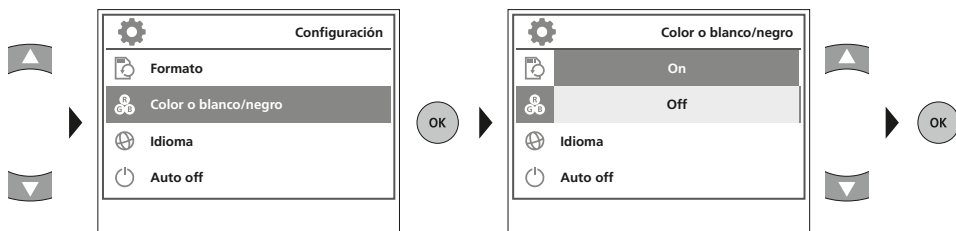

c. Cambiar idioma (EN, JP, FR, DE, IT, PT, NL, ES)

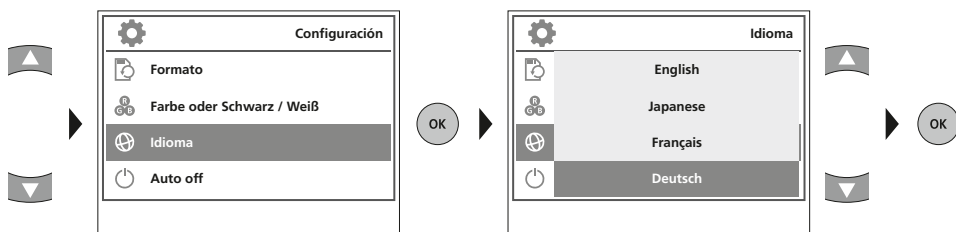

d. Parada automática

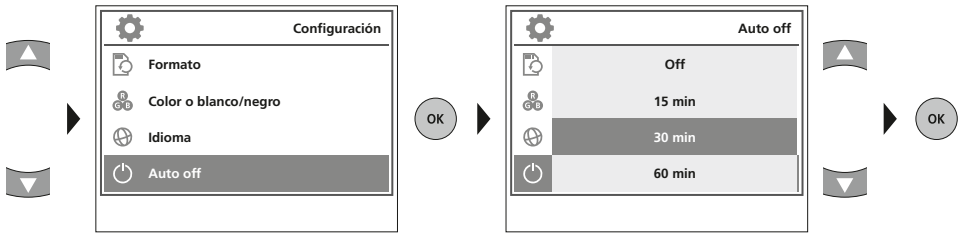

e. Configuración original

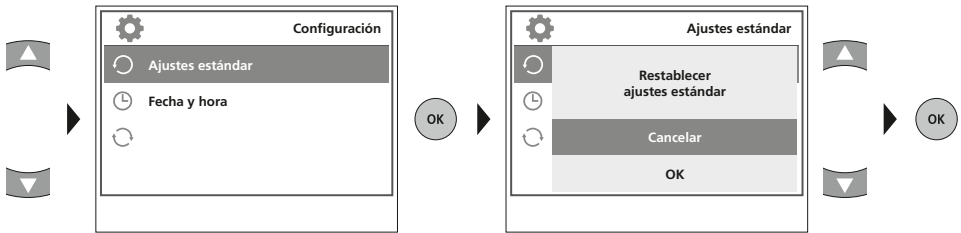

f. Ajustar fecha y hora

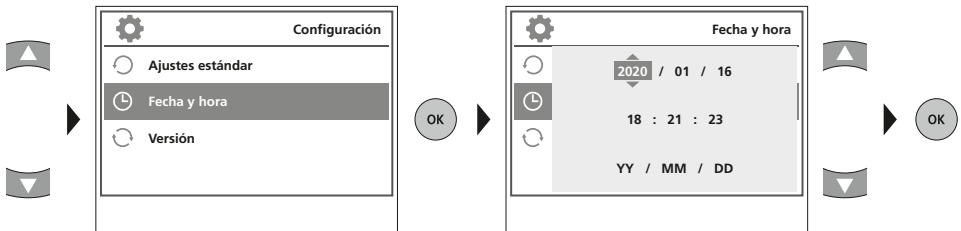

g. Versión del Firmware

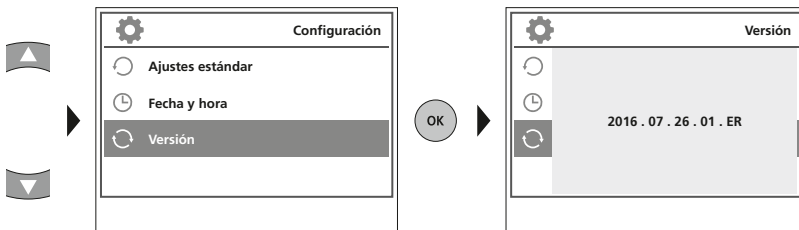

5 Modo de grabación

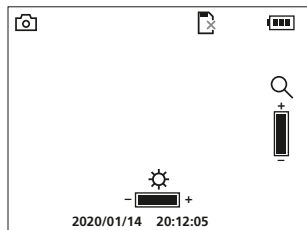

Toma de imágenes y vídeos

Orientar el cabezal de la cámara del tubo flexible y llevarlo a la posición deseada. Si las condiciones lumínicas son malas encienda la iluminación LED. Acerque o amplíe los objetos que se encuentren alejados o sean muy pequeños. Con la rotación manual de imágenes se puede girar la imagen del monitor 180°. Una pulsación breve de la tecla OK inicia la toma de imagen o la grabación de vídeo y se guarda esta en la tarjeta SD. Repetir la pulsación finaliza la grabación.

a. Cambio entre toma de imágenes y vídeos

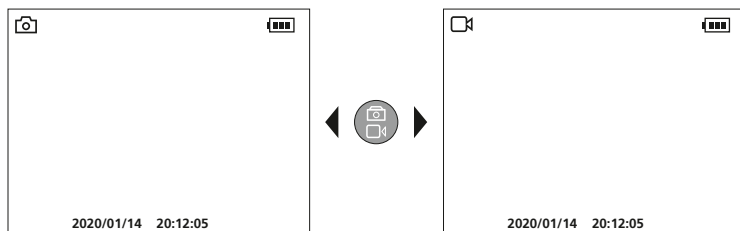

b. Iluminación LED

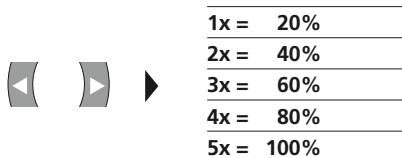
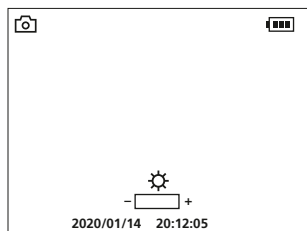

c. Zoom

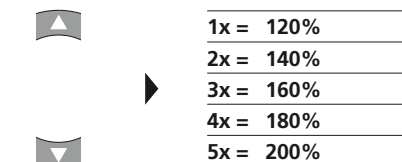
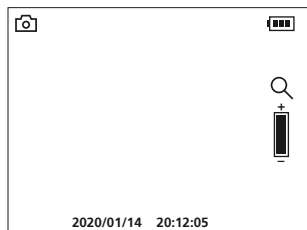

d. Rotación de imágenes / Simetría

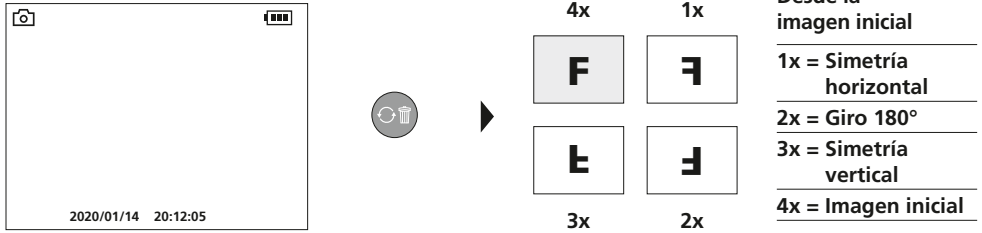

e. Tomar imagen

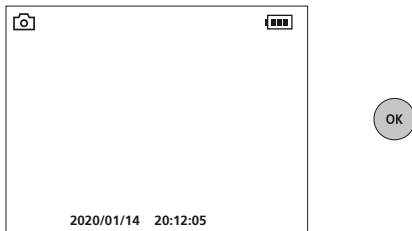

f. Iniciar o finalizar grabación de vídeo

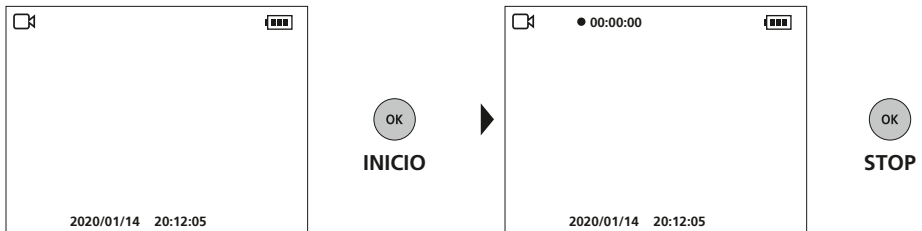

6 Orientación manual de la imagen

con unidad de cámara fija

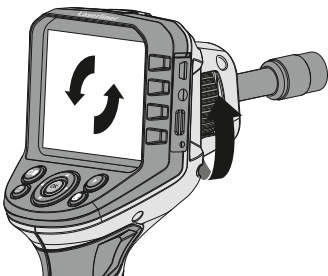

con unidad de cámara flexible

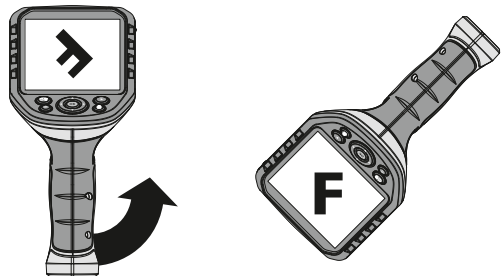

7 Modo de reproducción

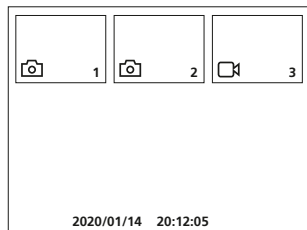

Reproducción de fotos y vídeos

Con la tecla „e” se accede a la galería de medios. Pulsando „OK” se muestra la imagen o el vídeo seleccionados en el modo de pantalla completa. Con las teclas de flechas se puede navegar por la galería de medios y en el modo de pantalla completa. El botón „f” cierra el modo de reproducción.

a. Navegar

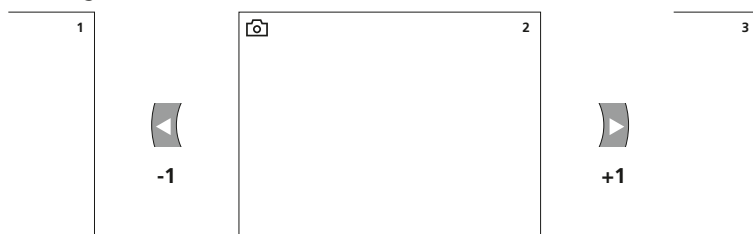

b. Borrar toma

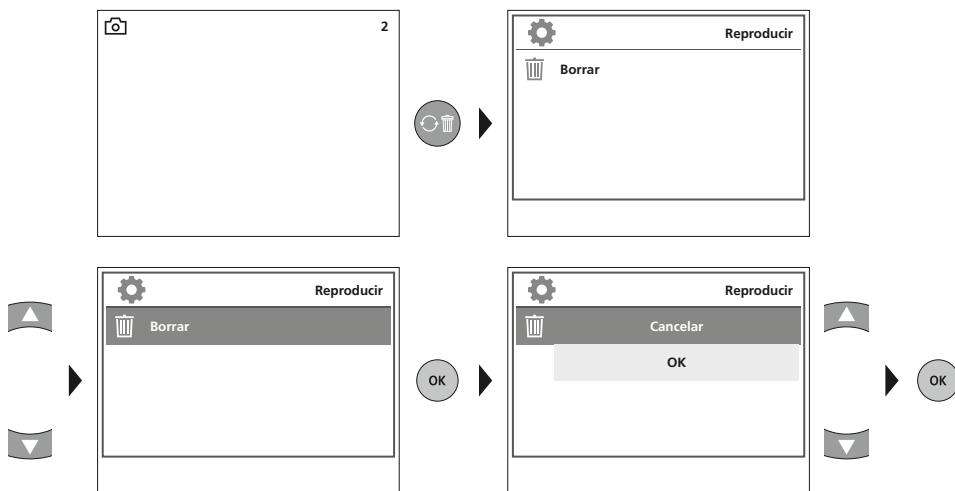

! Las tomas solo pueden ser borradas en el modo de pantalla completa.
! No se puede deshacer la operación de borrado.

! Formateando el soporte de datos se puede borrar todos los archivos y carpetas.
Ver al respecto el punto „4 a. Formatear soporte de datos”.

c. Reproducir

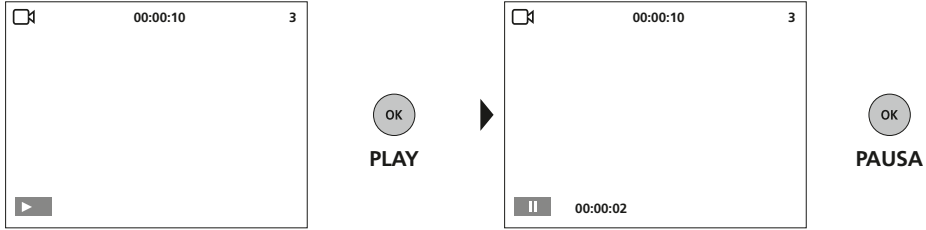

Con ESC se detiene la reproducción.

Transmisión de datos por USB

La transmisión de los datos almacenados en la tarjeta SD puede efectuarse bien con un lector de tarjetas compatible o bien directamente en el PC a través del puerto USB. Las instrucciones para conectar el ordenador y el adaptador de tarjetas o el lector de tarjetas figuran en el manual de su lector de tarjetas.

Conectar alimentador de red/cargador

Para cargar el aparato, enchufe el alimentador de red/cargador adjunto en el puerto USB tipo C „4” y luego en la toma de corriente correspondiente.

Datos técnicos		Sujeto a modificaciones técnicas. 21W09
Tipo de pantalla	Pantalla TFT en color de 3,5”	
Resolución de la pantalla	320 x 240 pixel	
Resolución de las imágenes y vídeos	640 x 480 pixel	
Formato de las imágenes y vídeos	JPEG / AVI	
Memoria	Tarjeta micro SD de hasta 16 GB	
Conexiones	USB tipo C, salida de vídeo Cinch	
Alimentación	Bloque de iones de litio de 3,7V / 2,8Ah	
Horas de servicio	aprox. 5 h	
Condiciones de trabajo	0°C ... 45°C, humedad del aire m. áx. 20 ... 85% h.r., no condensante, altitud de trabajo máx. 4000 m sobre el nivel del mar (nivel normal cero)	
Condiciones de almacén	-10°C ... 60°C, humedad del aire máx. 80% h.r.	
Medidas (An x Al x F)	181 x 207 x 96 mm	
Peso	342 g (Blouqe de batería incluido)	

Disposiciones europeas y eliminación

El aparato cumple todas las normas requeridas para el libre tráfico de mercancías en la UE.

Se trata de un aparato eléctrico, por lo que debe ser recogido y eliminado por separado conforme a la directiva europea relativa a los aparatos eléctricos y electrónicos usados.

Más información detallada y de seguridad en: <http://laserliner.com/info?an=AGG>



! Leggere attentamente le istruzioni per l'uso, l'opuscolo allegato "Ulteriori informazioni e indicazioni garanzia", nonché le informazioni e le indicazioni più recenti raggiungibili con il link riportato al termine di queste istruzioni. Questo documento deve essere conservato e fornito insieme all'apparecchio in caso questo venga inoltrato a terzi.

Funzione / Utilizzo

Collegato a un'unità obiettivo intercambiabile, questo sistema di videoispezione professionale VideoFlex G4 consente di eseguire facilmente un controllo visivo in punti difficilmente accessibili, come tubi, cavità, sotterranei, muri e autoveicoli. Le registrazioni di immagini e video possono essere salvate sulla scheda di memoria SDHC per analizzare e documentare i dati.

Indicazioni generali di sicurezza

- Utilizzare l'apparecchio esclusivamente in conformità con gli scopi previsti e nei limiti delle specificazioni.
- Gli apparecchi di misurazione e gli accessori non sono giocattoli. Conservare lontano dalla portata di bambini.
- La struttura dell'apparecchio non deve essere modificata.
- Non sottoporre l'apparecchio a carichi meccanici, elevate temperature, umidità o forti vibrazioni.
- Non utilizzare più l'apparecchio in caso di guasto di una o più funzioni oppure se le batterie sono quasi scariche.
- In esterni l'apparecchio può essere utilizzato solo con determinate condizioni atmosferiche o con appropriate misure di sicurezza.
- L'unità LCD non deve essere immersa in acqua. L'apparecchio base non deve venire a contatto con liquidi.
- La VideoFlex G4 non deve venire mai a contatto con sostanze chimiche, tensione ed oggetti mobili o ad alta temperatura. Ciò potrebbe danneggiare l'apparecchio e causare gravi lesioni dell'utente.
- La VideoFlex G4 non deve essere utilizzata per analisi mediche o di persone.
- Attenersi alle misure di sicurezza stabilite dagli enti locali e nazionali relative al corretto utilizzo dell'apparecchio.
- L'apparecchio non è adatto a misurazioni nelle vicinanze di tensioni pericolose. Pertanto, per eseguire misurazioni nelle vicinanze di impianti elettrici, assicurarsi sempre che gli elementi conduttivi non siano sotto tensione. Garantire l'assenza di tensione e la protezione da riattivazione prendendo dei provvedimenti adeguati.

Indicazioni di sicurezza

Lavorare in presenza di radiazione elettromagnetica

- L'apparecchio rispetta le norme e i valori limite per la compatibilità elettromagnetica ai sensi della direttiva EMC 2014/30/UE.
- Rispettare le restrizioni locali all'uso, ad es. in ospedali, a bordo di aerei, in stazioni di servizio o nelle vicinanze di persone portatrici di pacemaker. Presenza di un influsso pericoloso o di un disturbo degli e da parte degli apparecchi elettronici.

Indicazioni per la manutenzione e la cura

Pulire tutti i componenti con un panno leggermente inumidito ed evitare l'impiego di prodotti detergenti, abrasivi e solventi. Rimuovere la batteria/le batterie prima di un immagazzinamento prolungato. Immagazzinare l'apparecchio in un luogo pulito e asciutto.

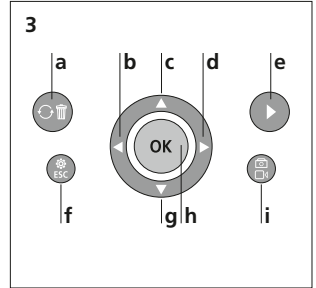
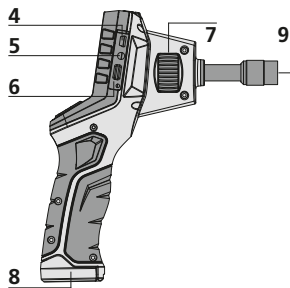
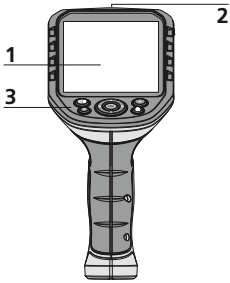

- 1 Display LC
- 2 ON/OFF
- 3 Tasti di avvio rapido
- 4 Interfaccia USB tipo C
- 5 Uscita video
- 6 Slot scheda micro SD
- 7 Rotella unità obiettivo
- 8 Vano batteria ricaricabile
- 9 Collegamento unità obiettivo

- a Rotazione 180° / Speculare / Eliminazione riprese
- b Comando menu / LED di illuminazione -
- c Comando menu / Zoom +
- d Comando menu / LED di illuminazione +
- e Galleria immagini e video

- f Modalità di impostazione / Interrompi
- g Comando menu / Zoom -
- h Scatto / Ripresa / Conferma
- i Commutazione immagine / video

Modalità di ripresa immagini

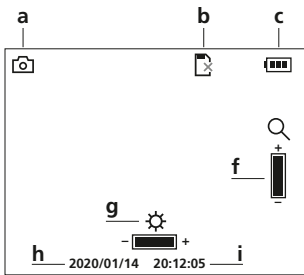

Modalità di ripresa video

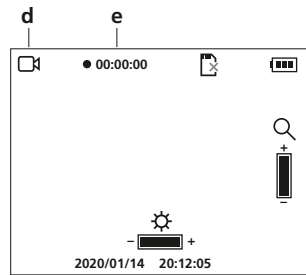

- a Ripresa immagine
- b Inserire scheda SD
- c Stato delle batterie
- d Ripresa video
- e REC: registrazione in corso
- f Zoom
- g LED di illuminazione
- h Data attuale
- i Ora attuale

Modalità riproduzione immagine

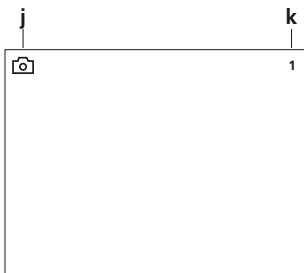



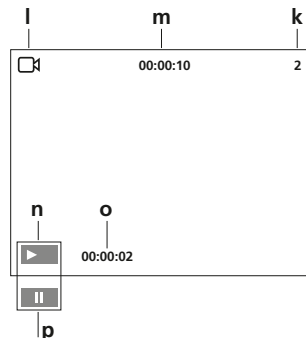



Modalità riproduzione video



- j Ripresa immagine
- k Numero ripresa
- l Ripresa video
- m Data ripresa
- n Play
- o Durata riproduzione
- p Pausa

Modalità di impostazione

Impostazioni	
	Formato — q
	A colori o in bianco e nero — r
	Lingua — s
	Spegnimento automatico — t

Impostazioni	
	Impostazioni standard — u
	Data/ora — v
	Versione — w

- q** Formattazione supporto dati
- r** Cambia modalità a colori
- s** Modifica lingua (EN, JP, FR, DE, IT, PT, NL, ES)
- t** Spegnimento automatico
- u** Impostazione di fabbrica
- v** Impostazione data/ora
- w** Versione firmware

Messa in servizio

1 Connettore tubo flessibile

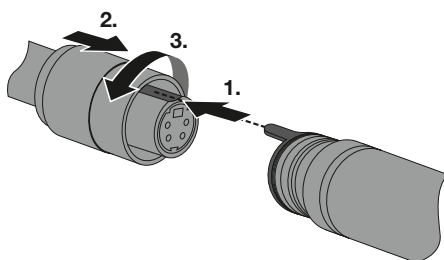

2 ON/OFF

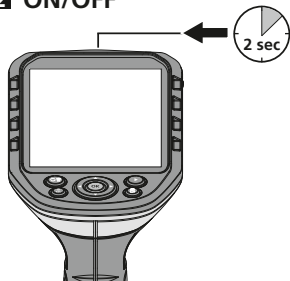

RESET

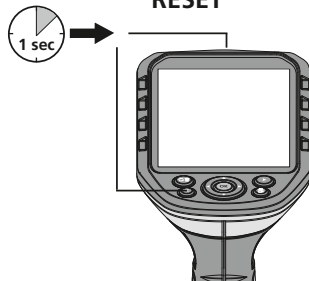

3 Inserimento della microscheda SD

Per inserire la microscheda SD, aprire la copertura in gomma e inserire la scheda come indicato nell'immagine. Senza un supporto di memorizzazione non sono possibili le registrazioni.

! Spegnere il dispositivo prima di estrarre la scheda microSD.

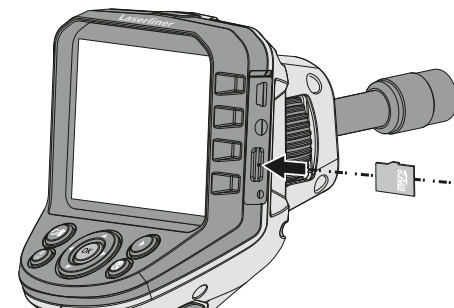

4 Modalità di impostazione

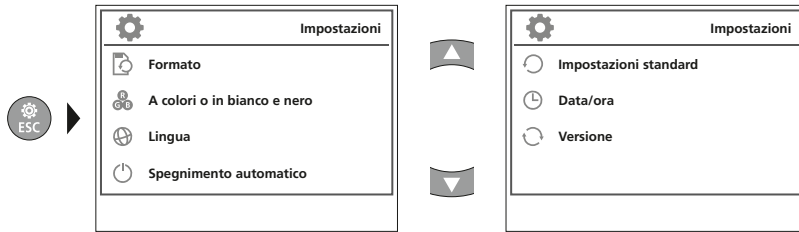

Per ritornare alla modalità di ripresa, premere ripetutamente il tasto ESC.

a. Formattazione supporto dati

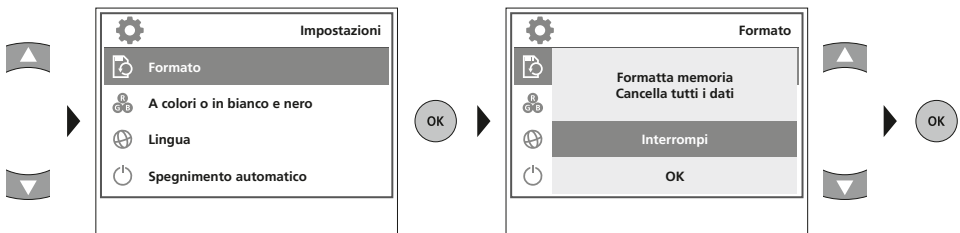

! Tutti i dati sulla scheda SD saranno cancellati. Questa operazione non può essere annullata. Non viene chiesta conferma per l'operazione.

b. Cambia modalità a colori

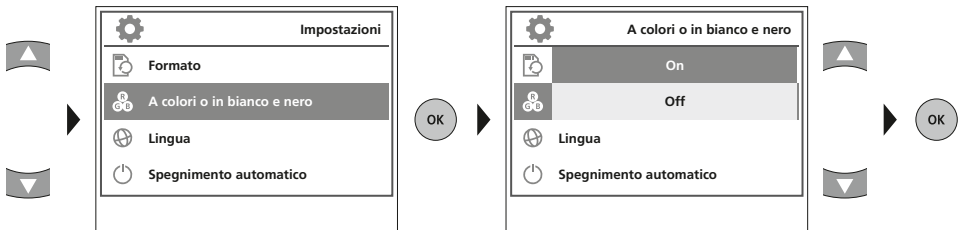

c. Modifica lingua (EN, JP, FR, DE, IT, PT, NL, ES)

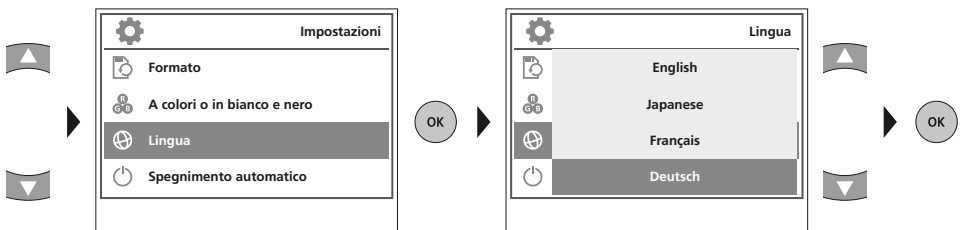

d. Spegnimento automatico

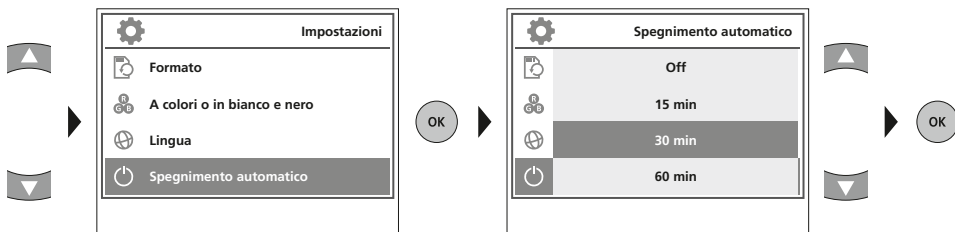

e. Impostazione di fabbrica

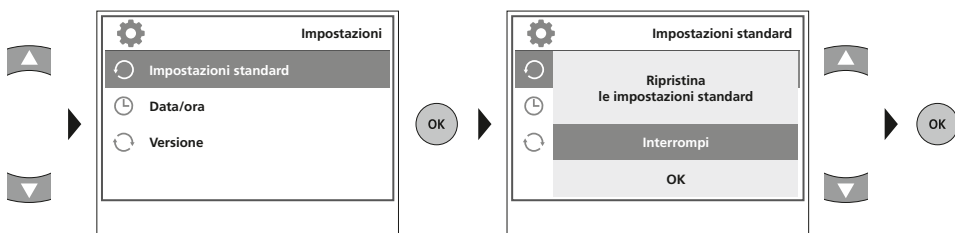

f. Impostazione data/ora

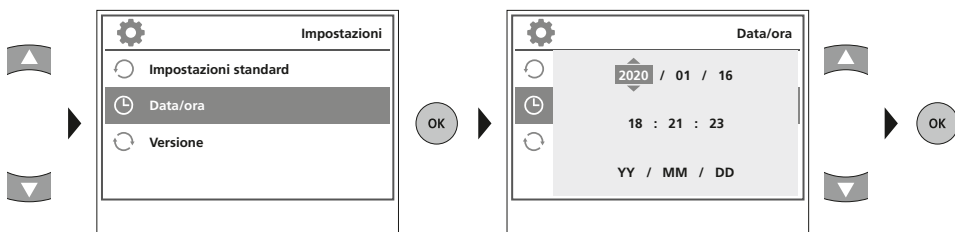

g. Versione firmware

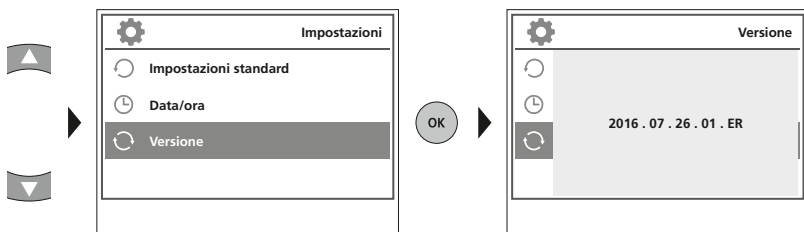

5 Modalità di ripresa

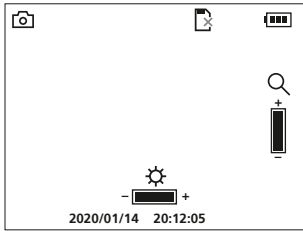

Ripresa di immagini/video

Posizionare la testina di ripresa sul tubo flessibile e condurla al punto desiderato. In caso di luce insufficiente accendere il LED di illuminazione. Utilizzare lo zoom per ingrandire oggetti piccoli o lontani. L'immagine può essere ruotata di 180° con la funzione di rotazione manuale. Premendo brevemente il tasto OK, viene effettuata la ripresa immagine o video e memorizzata sulla scheda SD. Premendolo di nuovo si termina la ripresa.

a. Commutazione registrazione immagine/video

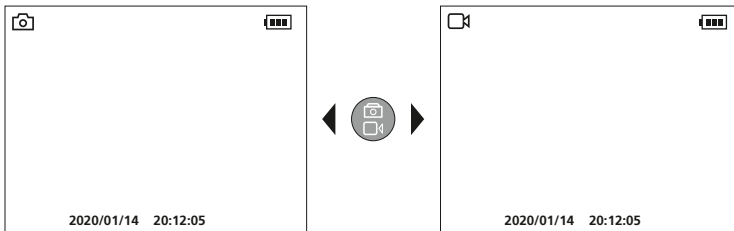

b. LED di illuminazione

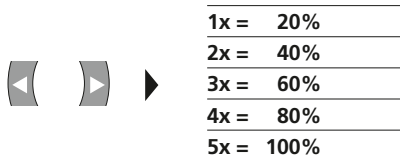
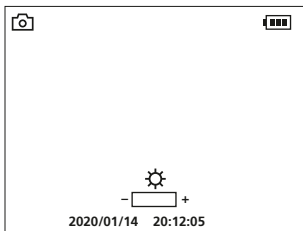

c. Zoom

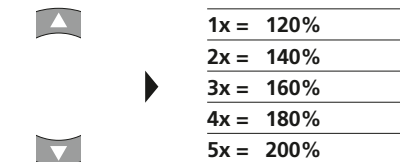
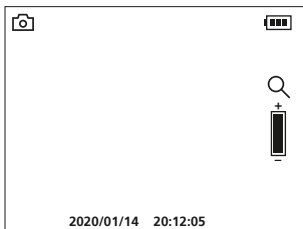

d. Rotazione immagine / Speculare

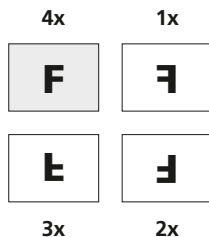
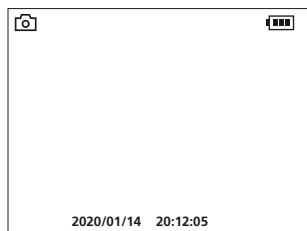

Dall'immagine iniziale

1x = immagine speculare orizzontale

2x = Rotazione a 180°

3x = Immagine speculare verticale

4x = Immagine iniziale

e. Ripresa immagine

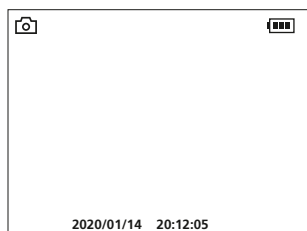

f. Start/stop ripresa video

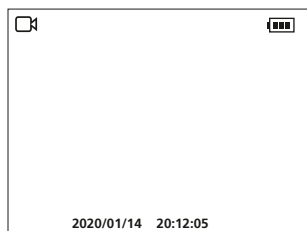

START

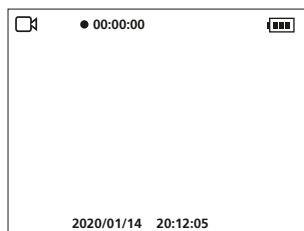

STOP

6 Allineamento manuale delle immagini

con unità obiettivo fissa

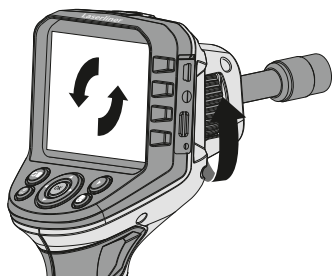

con unità obiettivo flessibile

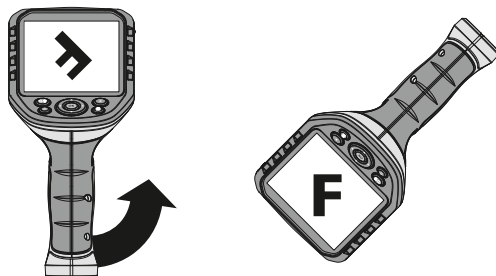

7 Modalità di riproduzione

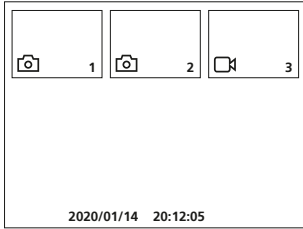

Riproduzione di immagini/video

Premendo il tasto „e” si accede alla galleria immagini e video. Premendo „OK” si passa alla visualizzazione a schermo intero dell’immagine o del video selezionato/a. Con i tasti freccia si può navigare nella galleria immagini e video e in modalità a schermo intero. Premendo il tasto “f”, si può chiudere la modalità di riproduzione.

a. Navigazione

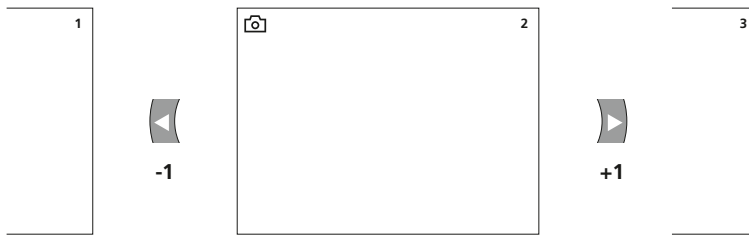

b. Cancella ripresa

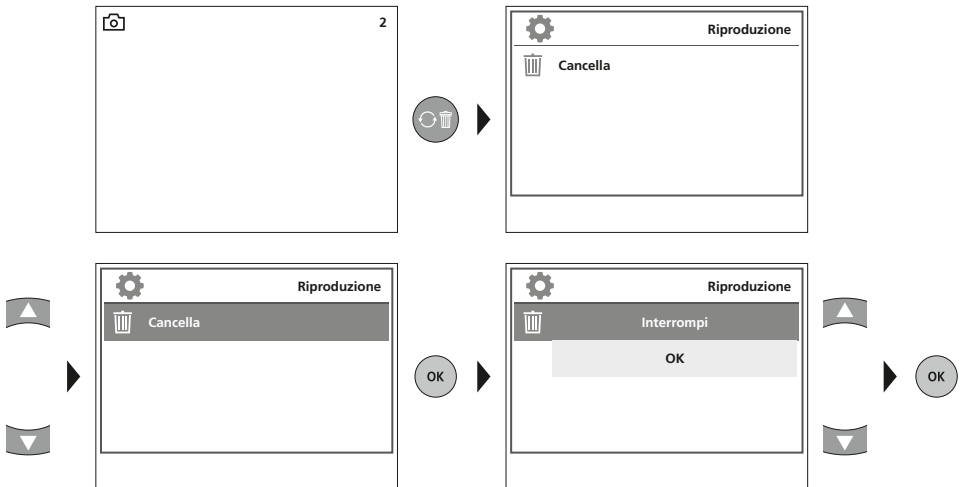

Le riprese possono essere cancellate solo in modalità a schermo intero. L’operazione di cancellazione non può essere annullata.



Formattando il supporto dati si possono cancellare tutti i file e tutte le cartelle. A riguardo vedi punto „4 a. Formattazione supporto dati”.

c. Riproduzione

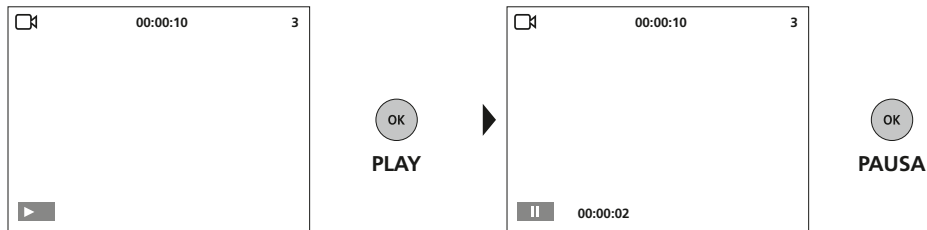

Premendo il tasto ESC si interrompe la riproduzione.

Trasmissione dati USB

I dati salvati sulla scheda SD possono essere trasmessi al PC con un lettore di schede adatto o direttamente attraverso la porta USB. Per informazioni sul collegamento tra computer e adattatore o lettore di schede consultare il manuale del lettore di schede.

Collegare alimentatore/caricabatteria

Per caricare l'apparecchio inserire l'alimentatore/caricabatterie fornito in dotazione nell'interfaccia USB tipo C „4“ e collegarlo con la relativa fonte di corrente.

Dati tecnici

Con riserva di modifiche tecniche 21W09

Tipo di display	Display a colori TFT da 3,5"
Risoluzione del display	320 x 240 pixel
Risoluzione immagine / video	640 x 480 pixel
Formato immagine / video	JPEG / AVI
Memoria	Scheda di memoria microSD fino a 16 GB
Attacchi	USB tipo C, uscita video Cinch
Alimentazione elettrica	Gruppo batterie agli ioni di litio da 3,7V / 2,8Ah
Durata di esercizio	circa 5 ore
Condizioni di lavoro	0°C a 45°C, umidità dell'aria max. da 20 a 85% rH, non condensante, altezza di lavoro max. 4000 m sopra il livello del mare (zero normale)
Condizioni di stoccaggio	-10°C a 60°C, umidità dell'aria max. 80% rH
Dimensioni (L x H x P)	181 x 207 x 96 mm
Peso	342 g (con batterie)

Norme UE e smaltimento

L'apparecchio soddisfa tutte le norme necessarie per la libera circolazione di merci all'interno dell'UE.

Questo prodotto è un apparecchio elettrico e deve pertanto essere raccolto e smaltito separatamente in conformità con la direttiva europea sulle apparecchiature elettriche ed elettroniche usate.

Per ulteriori informazioni ed indicazioni di sicurezza:

<http://laserliner.com/info?an=AGG>





SERVICE



Umarex GmbH & Co. KG

– Laserliner –

Möhnstraße 149, 59755 Arnsberg, Germany

Tel.: +49 2932 638-300, Fax: +49 2932 638-333

info@laserliner.com

Umarex GmbH & Co. KG

Donnerfeld 2

59757 Arnsberg, Germany

Tel.: +49 2932 638-300, Fax: -333

www.laserliner.com



Laserliner