

# VideoInspector 3D

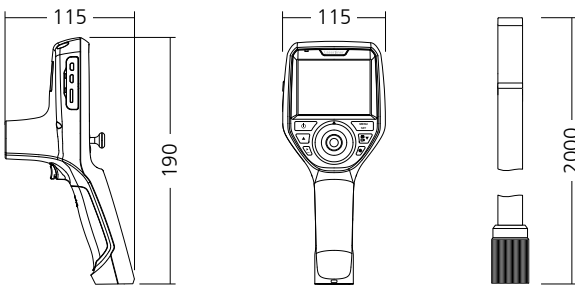

DE 02

EN 13

NL 24

DA 35

FR 46

ES 57

IT 68

PL

FI

PT

SV

NO

TR

RU

UK

CS

ET

RO

BG

EL

**Laserliner**



Lesen Sie die Bedienungsanleitung, das beiliegende Heft „Garantie- und Zusatzhinweise“ sowie die aktuellen Informationen und Hinweise im Internet-Link am Ende dieser Anleitung vollständig durch. Befolgen Sie die darin enthaltenen Anweisungen. Diese Unterlage ist aufzubewahren und bei Weitergabe des Gerätes mitzugeben.

## Funktion / Verwendung

Dieser Videoinspektor liefert farbige Videobilder mittels einer Mikrokamera an das LCD zur Überprüfung schwer zugänglicher Stellen wie z.B. Hohlräumen, Schächten, Mauerwerk oder im KFZ.

## Allgemeine Sicherheitshinweise

- Setzen Sie das Gerät ausschließlich gemäß dem Verwendungszweck innerhalb der Spezifikationen ein.
- Die Messgeräte und das Zubehör sind kein Kinderspielzeug. Vor Kindern unzugänglich aufbewahren.
- Baulich darf das Gerät nicht verändert werden.
- Setzen Sie das Gerät keiner mechanischen Belastung, enormen Temperaturen, Feuchtigkeit oder starken Vibrationen aus.
- Das Gerät darf nicht mehr verwendet werden, wenn eine oder mehrere Funktionen ausfallen oder die Batterieladung schwach ist.
- Achten Sie beim Außeneinsatz darauf, dass das Gerät nur unter entsprechenden Witterungsbedingungen bzw. bei geeigneten Schutzmaßnahmen eingesetzt wird.
- Das Netz-/Ladegerät nur innerhalb geschlossener Räume verwenden, weder Feuchtigkeit noch Regen aussetzen, da ansonsten die Gefahr eines elektrischen Stromschlages besteht.
- Vor Einsatz des Gerätes Akku voll aufladen.
- Verwenden Sie ausschließlich das Original-Zubehör. Wird falsches Zubehör verwendet, erlischt die Garantie.
- Der Ladevorgang ist abgeschlossen, wenn die Betriebsanzeige grün leuchtet.
- Bei schwacher Ladung des Akkus wird im Display ein rotes Batteriesymbol mit einem Ausrufezeichen angezeigt.
- Der Akku kann auch während des Betriebes geladen werden.
- Das Netzteil vom Netz trennen, wenn das Gerät nicht in Gebrauch ist.
- Die LCD-Einheit darf nicht in Wasser getaucht werden. Das Basisgerät darf nicht mit Flüssigkeit in Berührung kommen.
- Der Kamerakopf ist nicht säurebeständig oder feuerfest.
- Es ist unbedingt darauf zu achten, dass der Videoinspektor 3D nicht in Kontakt mit Chemikalien, Spannung, beweglichen oder heißen Gegenständen kommt. Dies kann zur Beschädigung des Gerätes und auch zu schweren Verletzungen des Bedieners führen.
- Der Messkopf kann sich im Betrieb stark erwärmen und zu Beschädigungen von empfindlichem Messgut führen.
- Der Videoinspektor 3D darf nicht für medizinische Untersuchungen / Personenuntersuchung verwendet werden.
- Um die Schutzklasse IP 68 zu gewährleisten, muss die Abdeckkappe der Anschlüsse fest verschlossen sein.
- Bitte beachten Sie zur sachgemäßen Verwendung des Gerätes die Sicherheitshinweise von lokalen bzw. nationalen Behörden.
- Das Gerät ist nicht zur Messung in der Nähe von gefährlicher Spannung geeignet. Daher bei Messungen in der Nähe elektrischer Anlagen immer auf die Spannungsfreiheit leitfähiger Teile achten. Die Spannungsfreiheit und Sicherung gegen Wiedereinschalten muss durch geeignete Maßnahmen gewährleistet sein.

## Sicherheitshinweise

Umgang mit künstlicher, optischer Strahlung OStrV

### Austrittsöffnung LED

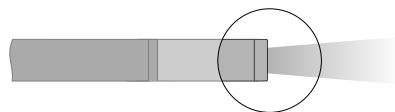

- Das Gerät arbeitet mit LEDs der Risikogruppe RG 0 (freie Gruppe, kein Risiko) gemäß den gültigen Normen für die photobiologische Sicherheit (EN 62471:2008-09ff / IEC/TR 62471:2006-07ff) in ihren aktuellen Fassungen.
- Die zugängliche Strahlung der LEDs ist bei bestimmungsgemäßer Verwendung und unter vernünftigerweise vorhersehbaren Bedingungen für das menschliche Auge und die menschliche Haut ungefährlich.

## Sicherheitshinweise

Umgang mit elektromagnetischer Strahlung

- Das Messgerät hält die Vorschriften und Grenzwerte für die elektromagnetische Verträglichkeit gemäß EMV-Richtlinie 2014/30/EU ein.

## Sicherheitshinweise

Umgang mit elektromagnetischen Störungen

- Das Messgerät hält die Vorschriften und Grenzwerte für die Sicherheit und elektromagnetische Verträglichkeit gemäß der Richtlinien 2014/35/EU (Niederspannung / LVD) und 2014/30/EU (elektromagnetische Verträglichkeit / EMV) ein.
- Lokale Betriebseinschränkungen, z.B. in Krankenhäusern, in Flugzeugen, an Tankstellen oder in der Nähe von Personen mit Herzschrittmachern, sind zu beachten. Die Möglichkeit einer gefährlichen Beeinflussung oder Störung von und durch elektronische Geräte ist gegeben.

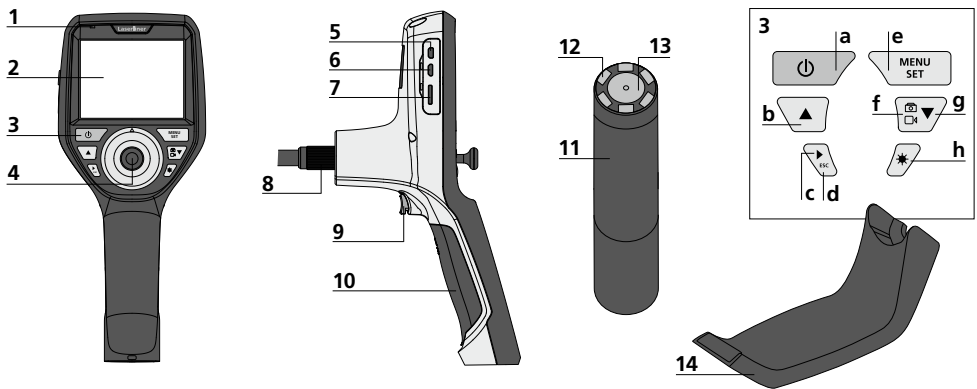

- 1 Betriebsanzeige
- 2 LC-Display
- 3 Direkttasten
- 4 Steuerhebel zur Drehung des Kamerakopfes
- 5 HDMI-Schnittstelle
- 6 Micro-USB-Schnittstelle / Ladebuchse

- 7 Steckplatz Micro-SD-Karte
- 8 Anschluss Flexschlauch
- 9 Auslöser
- 10 Batteriefach
- 11 Kamerakopf
- 12 LED
- 13 Linse
- 14 magnetische Halterung

- a ON/OFF / Standbild
- b Rotation 180° / Menü-Steuerung
- c Mediengalerie Bild / Video
- d Abbruch
- e Einstellungsmodus / Bestätigen / Aufnahmen aufrufen / Aufnahmen löschen

- f Umschaltung Bild / Video
- g Menü-Steuerung
- h LED-Beleuchtung

**HINWEIS:** Der VideInspector 3D liefert im Bereich von 2,5 - 10 cm vor dem Kamerakopf scharfe Bilder. Objekte außerhalb dieses Bereichs können unscharf erscheinen.

## Aufnahmemodus Bild

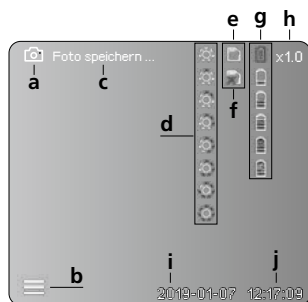

## Aufnahmemodus Video

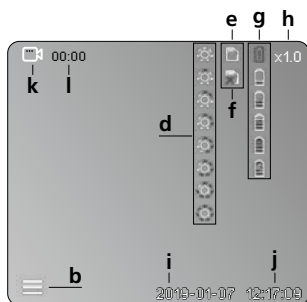

- a Aufnahme Bild
- b Menü geschlossen
- c Speichervorgang
- d LED-Beleuchtung
- e SD-Karte aktiv
- f SD-Karte einlegen
- g Batteriestatus
- h Zoom
- i aktuelles Datum
- j aktuelle Uhrzeit
- k Aufnahme Video
- l Aufnahme läuft

## Wiedergabemodus Bild



## Wiedergabemodus Video

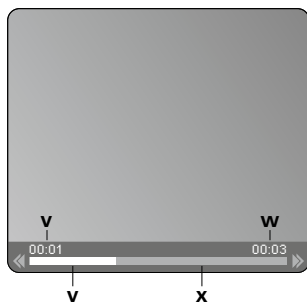

- m Aufnahmedatum
- n Aufnahmezeit
- o Zoom +
- p Zoom -
- q gezoomtes Bild navigieren
- r gezoomtes Bild navigieren
- s gezoomtes Bild navigieren
- t gezoomtes Bild navigieren
- u zurück zur Mediengalerie
- v abgespielte Zeit
- w Aufnahmedauer
- x Restdauer

## Einstellungsmodus

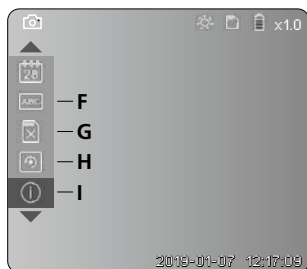
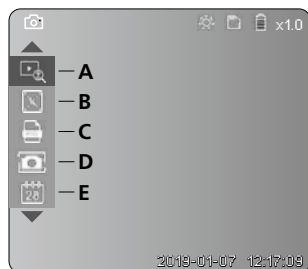

- A Zoom
- B Datums- und Zeitstempel
- C Bildformat
- D Bildrotation
- E Datum/Uhrzeit einstellen
- F Sprache ändern
- G Datenträger formatieren
- H Werkzeinstellung
- I Firmware-Version

## 1 ON / OFF



## 2 Micro-SD-Karte einlegen

Zum Einlegen einer Micro-SD-Karte zuerst die Gummiabdeckung öffnen und danach die Speicherkarte gemäß Abbildung einsetzen. Ohne Speichermedium sind keine Aufzeichnungen möglich.

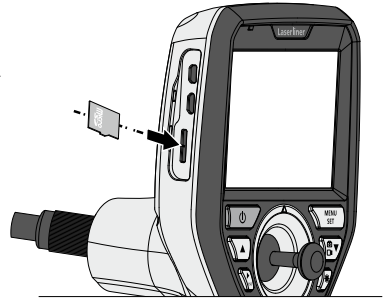

## 3 Einstellungsmodus

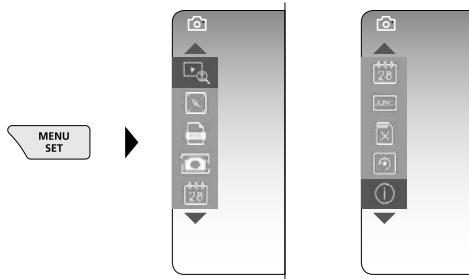

Um wieder in den Aufnahmemodus zu gelangen, die Taste ESC (mehrfach) drücken.

### a. Zoom

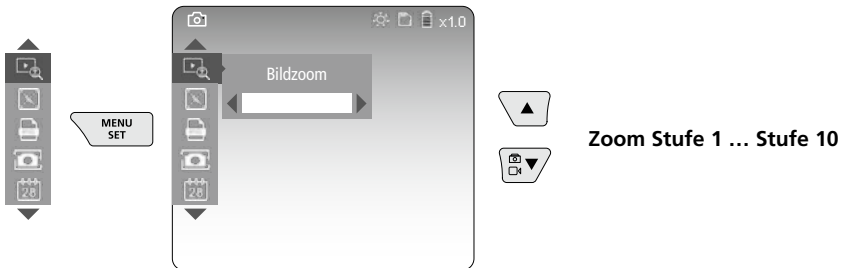

### b. Datums- und Zeitstempel

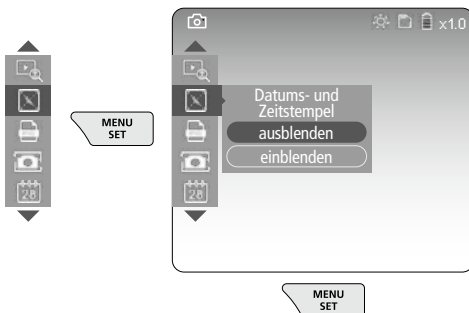

### c. Bildformat

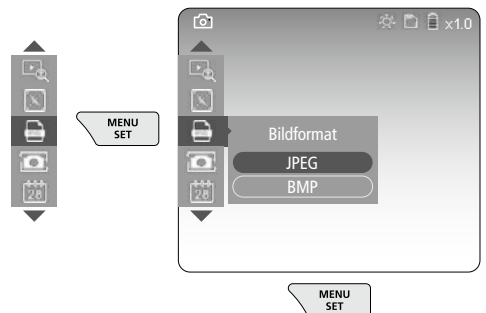

## d. Bildrotation

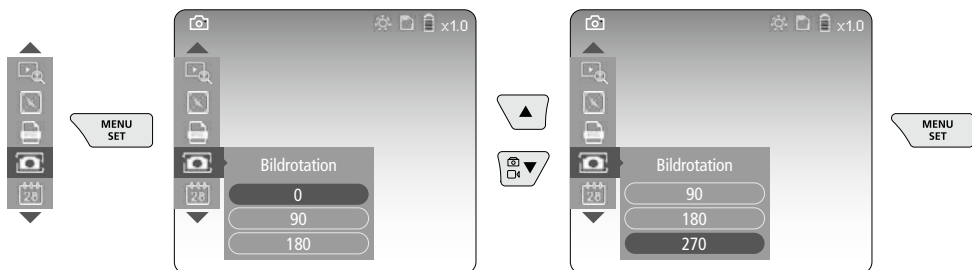

## e. Datum / Uhrzeit einstellen

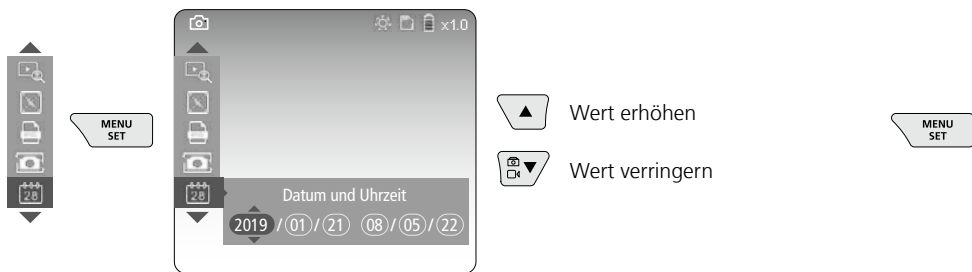

## f. Sprache ändern (ZH-CN, ZH-TW, EN, JA, KO, FR, DE, PT, ES, RU, IT, NL)

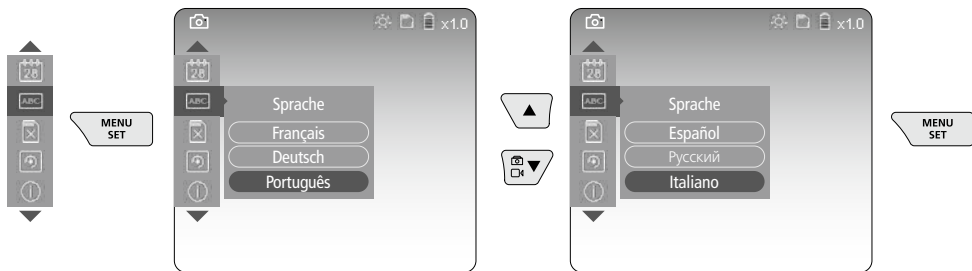

## g. Datenträger formatieren

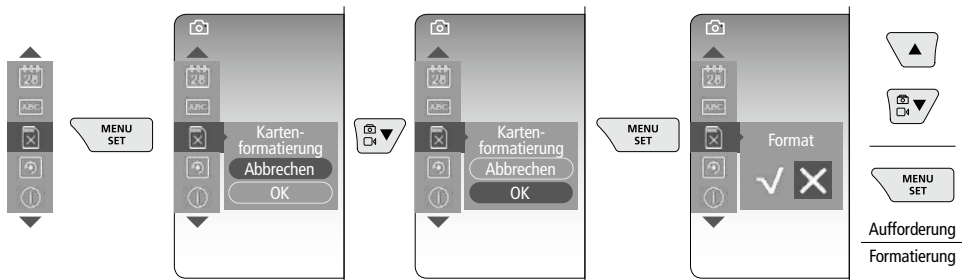

## h. Werkseinstellung

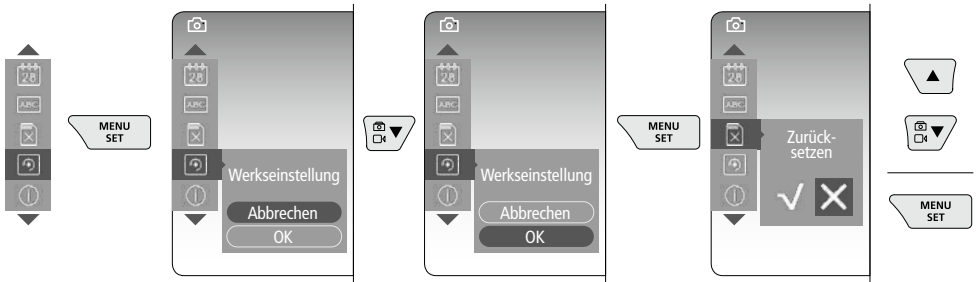

## i. Firmware-Version / Systemaktualisierung

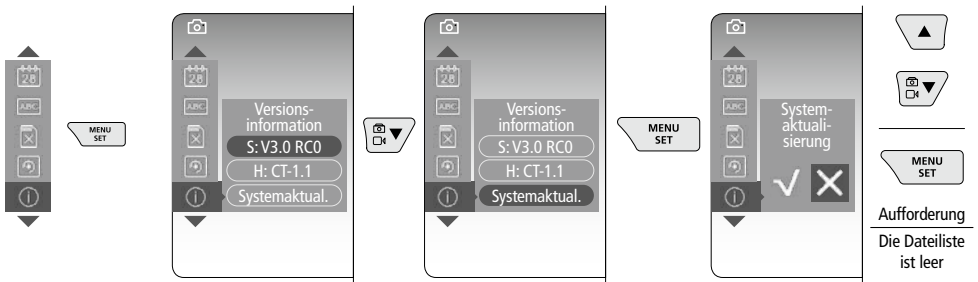

**!** Zur Durchführung einer Systemaktualisierung wenden Sie sich an die Serviceabteilung von UMAREX-LASERLINER.

## 4 Aufnahmemodus

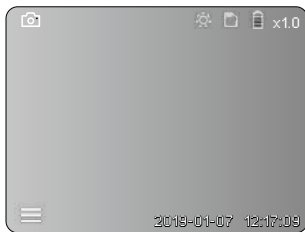

### Bild-/Videoaufnahmen

Kamerakopf am Flexschlauch an die gewünschte Position führen und mit dem Steuerhebel (4) ausrichten. Bei schlechten Lichtverhältnissen LED-Beleuchtung einschalten. Weiter entfernte oder kleine Objekte heranzoomen. Durch die manuelle Bildrotation kann das Bild auf dem Monitor in 90°-Schritten gedreht werden. Durch kurzes Betätigen des Auslösers (9) wird das Bild oder die Videoaufnahme aufgenommen und auf der SD-Karte gespeichert. Erneutes Drücken beendet die Videoaufnahme.

## a. Umschaltung Aufnahme Bild / Video

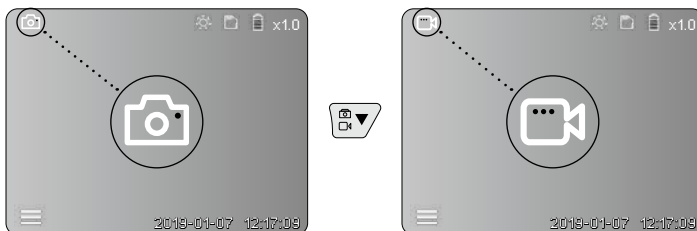

## b. Ausrichten des Kamerakopfes

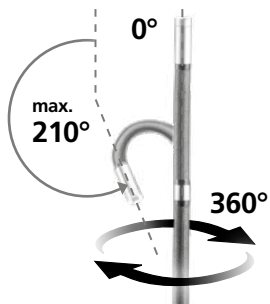
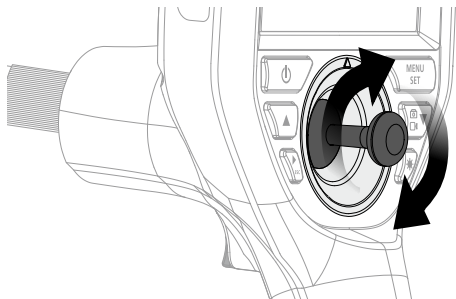

## c. LED-Beleuchtung

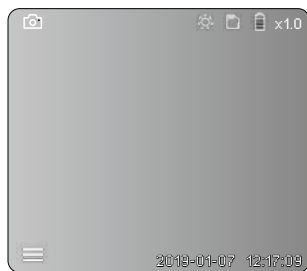

1x		AUS
2x		LED Stufe 1
3x		LED Stufe 2
4x		LED Stufe 3
5x		LED Stufe 4
6x		LED Stufe 5
7x		LED Stufe 6
8x		LED Stufe 7

## d. Zoom (siehe Kapitel 3 a.)

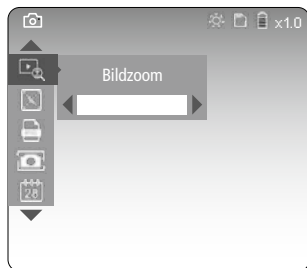

## e. Bildrotation

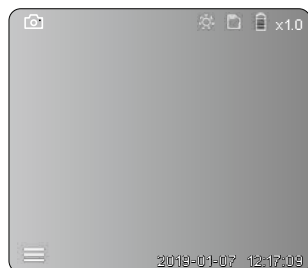

- 1x = Drehung 90°
- 2x = Drehung 90°
- 3x = Drehung 90°
- 4x = Ausgangsbild

## f. Aufnahme Bild / Video

Durch kurzes Betätigen des Auslösers (9) wird das Bild oder die Videoaufnahme aufgenommen und auf der SD-Karte gespeichert. Erneutes Drücken beendet die Videoaufnahme.





## 5 Wiedergabemodus



### Wiedergabe von Bild-/Videoaufnahmen

Durch Drücken der Taste „c“ wird die Mediengalerie aufgerufen. Durch erneutes Drücken der Taste „c“ wird der Wiedergabemodus geschlossen.

### a. Wiedergabe und Löschen von Bild-/Videoaufnahmen

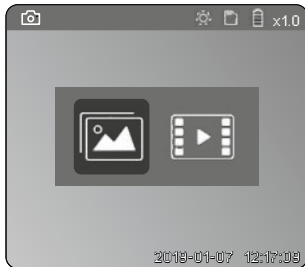

Auswahl  
Bild / Video



Auswahl  
bestätigen

#### Wiedergabemodus Bild

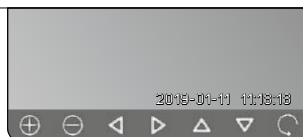
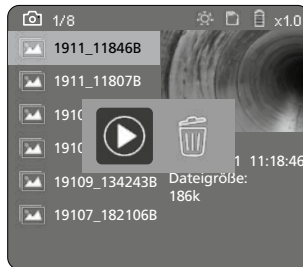
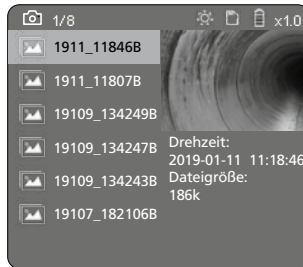

#### Wiedergabemodus Video

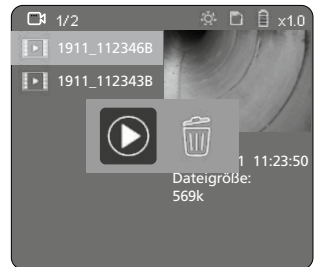
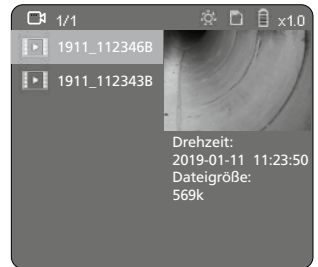

## b. Aufnahme löschen

Zum Löschen einer Bild- oder Videoaufnahme das Bild in der Mediengalerie aufrufen, siehe Kapitel 5 a.

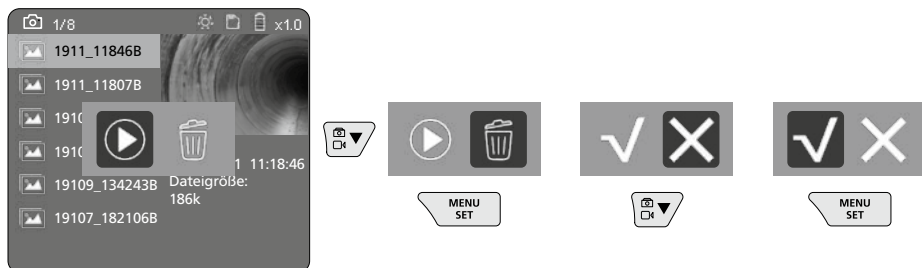

! Der Löschvorgang kann nicht widerrufen werden.

! Über die Formatierung des Datenträgers können alle Dateien und Ordner gelöscht werden. Siehe hierzu Punkt „3 g. Datenträger formatieren“.

## USB-Datenübertragung

Die gespeicherten Daten auf der SD-Karte können mit dem mitgelieferten Kartenlesegerät auf den PC übertragen werden.

## Kamerakopf / Fokus

Der Videolinspektionskopf 3D liefert im Bereich von 2,5 - 10 cm vor dem Kamerakopf scharfe Bilder.

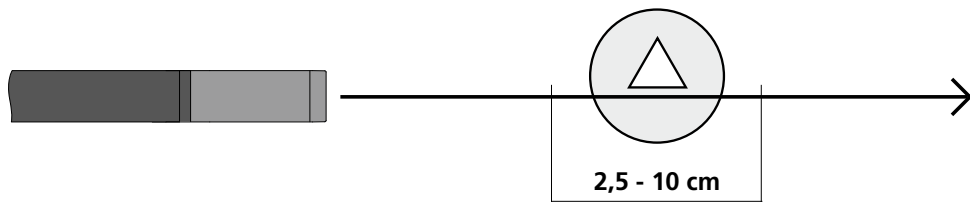

Objekte die weit außerhalb dieses Bereichs liegen, können unscharf erscheinen.

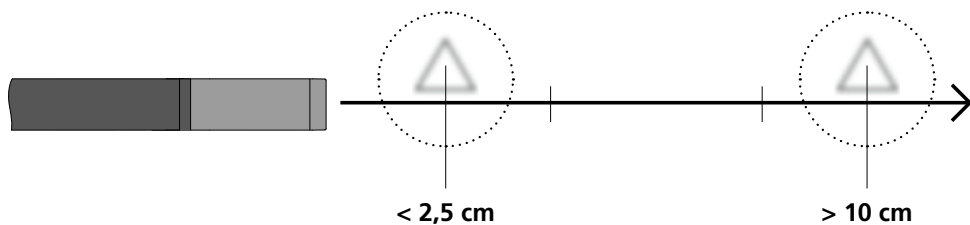

## Wechseln des Akkus

Magnetische Halterung entfernen, das Akkufach öffnen und Akku gemäß den Installationssymbolen einlegen. Dabei auf korrekte Polarität achten.

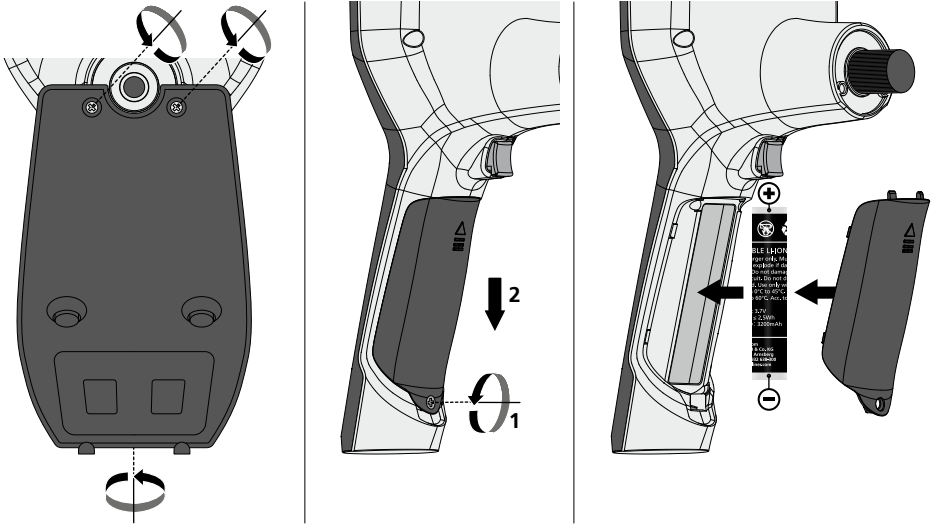

## Netz-/Ladegerät anschließen

Schließen Sie zum Laden des Gerätes das mitgelieferte Netz-/Ladegerät an die Micro-USB-Schnittstelle / Ladebuchse „6“ und verbinden es mit einer entsprechenden Stromquelle.

## Austausch der Kameraeinheit

Die Kameraeinheit lässt sich einfach entnehmen und austauschen. Dazu die Schraube lösen und die Kameraeinheit am Steuerhebel herausziehen.

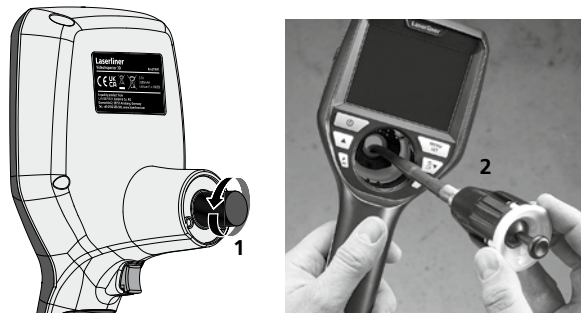

## Gefährdung durch starke Magnetfelder

Starke Magnetfelder können schädliche Einwirkungen auf Personen mit aktiven Körperhilfsmitteln (z.B. Herzschrittmacher) und an elektromechanischen Geräten (z.B. Magnetkarten, mechanischen Uhren, Feinmechanik, Festplatten) verursachen.

Hinsichtlich der Einwirkung starker Magnetfelder auf Personen sind die jeweiligen nationalen Bestimmungen und Vorschriften zu berücksichtigen, wie beispielsweise in der Bundesrepublik Deutschland die berufsgenossenschaftliche Vorschrift BGI 11 § 14 „Elektromagnetische Felder“.

Um eine störende Beeinflussung zu vermeiden, halten Sie die Magnete stets in einem Abstand von mindestens 30 cm von den jeweils gefährdeten Implantaten und Geräten entfernt.

## Hinweise zur Wartung und Pflege

Reinigen Sie alle Komponenten mit einem leicht angefeuchteten Tuch und vermeiden Sie den Einsatz von Putz-, Scheuer- und Lösungsmitteln. Entnehmen Sie die Batterie/n vor einer längeren Lagerung. Lagern Sie das Gerät an einem sauberen, trockenen Ort.

Technische Daten		Technische Änderungen vorbehalten. 21W41
<b>Durchmesser / Länge Kamerakopf</b>	ø 6 mm / 74 mm	
<b>Bildschirmtyp</b>	3,5" TFT-Farbdisplay	
<b>Auflösung Display</b>	640 x 480 Pixel	
<b>Bildformat / Videoformat</b>	JPEG / MP4	
<b>Beleuchtung</b>	7 Helligkeitsstufen	
<b>Digitalzoom</b>	10 Zoomstufen	
<b>Speicher</b>	Micro-SD Speicherkarte bis 8 GB	
<b>Schutzart</b>	Basiseinheit: IP 54 / Kamera-Sonde: Ip 68 (Tauchtiefe 1m, 60 Min.)	
<b>Min. Biegeradius Sonde</b>	75 mm	
<b>Anschlüsse</b>	Micro-USB, Netzteil 5V / DC	
<b>Auflösung Kamera</b>	960 x 720 Pixel	
<b>Sichtfeld (FOV)</b>	85°	
<b>Schärfentiefe (DOF)</b>	2,5 ... 10 cm	
<b>Durchmesser / Länge Sonde</b>	6 mm / 2 m	
<b>Stromversorgung</b>	Li-Ion Akkupack 3,7V / 1,7Ah / Netzteil 5V/DC / 2A	
<b>Betriebsdauer</b>	ca. 3,5 Std.	
<b>Ladezeit</b>	ca. 4 Std.	
<b>Arbeitsbedingungen</b>	-10°C ... 50°C, Luftfeuchtigkeit max. 20 ... 85% rH, nicht kondensierend, Arbeitshöhe max. 4000 m über NN (Normalnull)	
<b>Lagerbedingungen</b>	-20°C ... 60°C, Luftfeuchtigkeit max. 80% rH	
<b>Abmessungen (B x H x T)</b>	115 x 190 x 115 mm (ohne Flexschlauch und Halterung)	
<b>Gewicht</b>	485 g (inkl. Akkupack und Flexschlauch / ohne Halterung)	

## EU-Bestimmungen und Entsorgung

Das Gerät erfüllt alle erforderlichen Normen für den freien Warenverkehr innerhalb der EU.

Dieses Produkt ist ein Elektrogerät und muss nach der europäischen Richtlinie für Elektro- und Elektronik-Altgeräte getrennt gesammelt und entsorgt werden.

Weitere Sicherheits- und Zusatzhinweise unter: <http://laserliner.com/info?an=AIH>





Completely read through the operating instructions, the „Warranty and Additional Information“ booklet as well as the latest information under the internet link at the end of these instructions. Follow the instructions they contain. This document must be kept in a safe place and passed on together with the device.

## Function / Application

This inspection camera features a micro-camera which sends colour video images to the LCD so that areas which are difficult to access (cavities, shafts, masonry or inside cars, for example) can be checked.

## General safety instructions

- The device must only be used in accordance with its intended purpose and within the scope of the specifications.
- The measuring tools and accessories are not toys. Keep out of reach of children.
- The structure of the device must not be modified in any way.
- Do not expose the device to mechanical stress, extreme temperatures, moisture or significant vibration.
- The device must no longer be used if one or more of its functions fail or the battery charge is weak.
- When using the device outdoors, make sure that the weather conditions are appropriate and/or that suitable protection measures are taken.
- Use the power supply/charger unit only in closed rooms; do not expose to moisture or rain otherwise risk of electric shock.
- Charge the device's battery completely prior to use.
- Use only genuine accessories. Use of inappropriate accessories will invalidate the warranty.
- Charging is completed when the LED indicator lights green.
- A red battery symbol with an exclamation mark is shown on the display when the battery charge is low.
- The battery can also be charged while using the device.
- Disconnect the power pack from the mains when the device is not in use.
- The LCD unit must not be immersed in water. The base unit must not come in contact with liquids.
- The camera head is not acid-resistant or fireproof.
- Make sure that the VideInspector 3D does not come into contact with chemicals, power sources, moving or hot objects. This can damage the device and put its user at risk of serious injury.
- The measuring head can become very hot during operation and may damage sensitive materials.
- The VideInspector 3D must not be used for medical examinations / examining people.
- To maintain the IP 68 protection class, the caps on the connections must be firmly locked in.
- Please ensure compliance with the safety regulations set out by local and national authorities with regard to the correct and proper use of the device.
- The unit is not suitable for taking measurements close to dangerous voltages. Therefore always make sure that conductive parts are at zero potential when carrying out measurements in the vicinity of electrical systems. Safe isolation from the power supply and precautions to prevent systems being switched on again must be ensured by implementing suitable measures.

## Safety instructions

Using artificial, optical emission (OStrV)

### LED outlet

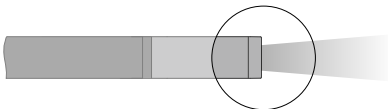

- The device works with LEDs of risk group RG 0 (exempt, no risk) in accordance with the latest versions of applicable standards relating to photobiological safety (EN 62471:2008-09ff / IEC/TR 62471:2006-07ff).
- When used for the intended purpose and under reasonably foreseeable conditions, the accessible radiation of the LEDs is safe for the human eye and skin.

## Safety instructions

Dealing with electromagnetic radiation

- The measuring device complies with electromagnetic compatibility regulations and limit values in accordance with EMC-Directive 2014/30/EU.

## Safety instructions

Dealing with electromagnetic interference

- The measuring device complies with the provisions and limit values for safety and electromagnetic compatibility in accordance with Directive 2014/35/EU (low voltage/LVD) and the Directive 2014/30/EU (electromagnetic compatibility/EMC).
- Local operating restrictions – for example, in hospitals, aircraft, petrol stations or in the vicinity of people with pacemakers – may apply. Electronic devices can potentially cause hazards or interference or be subject to hazards or interference.

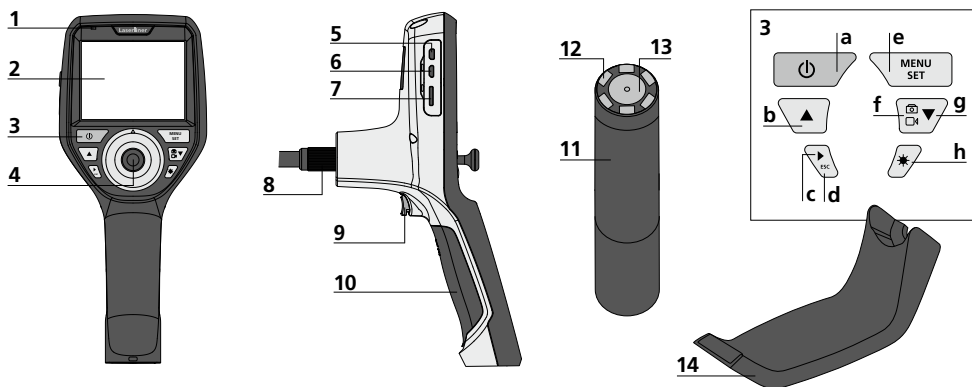

- |   |                             |  |                           |
|---|-----------------------------|--|---------------------------|
| 1 Operation indicator                   | 8 Connection for flex cable | a ON/OFF / Still image   | f Image / video selection |
| 2 LCD                                   | 9 Trigger                   | b Rotation 180° / Menu control                                   | g Menu control            |
| 3 Hot keys                              | 10 Battery compartment      | c Media gallery Image / video                                    | h LED lighting            |
| 4 Joystick to turn the camera head      | 11 Camera head              | d Cancel   |                           |
| 5 HDMI interface                        | 12 LED                      | e Settings mode / Confirm / Select recordings / Delete recording |                           |
| 6 Micro USB interface / Charging socket | 13 Lens                     |  |                           |
| 7 Micro SD card slot                    | 14 Magnetic holder          |  |                           |

**NOTE:** The Videolnspector 3D delivers sharp images in a range between 2.5 and 10 cm from the camera head. Objects outside this range may appear blurred.

## Image record mode

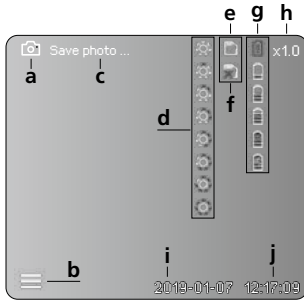

## Video record mode

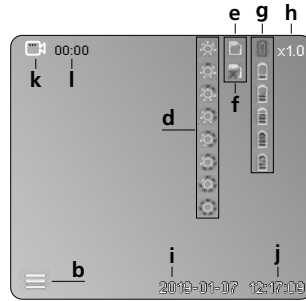

- a Image recording
- b Menu closed
- c Save
- d LED lighting
- e SD card active
- f Insert SD card
- g Battery status
- h Zoom
- i Current date
- j Current time
- k Video recording
- l Recording

## Image playback mode

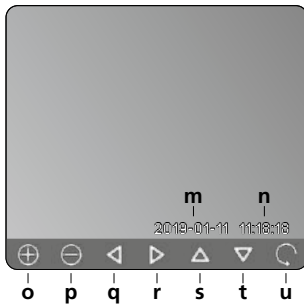

## Video playback mode

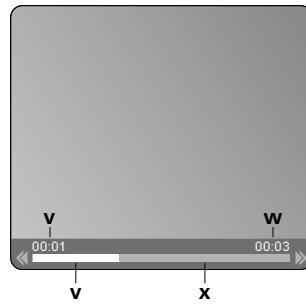

- m Recording date
- n Recording time
- o Zoom +
- p Zoom -
- q Navigate zoomed image
- r Navigate zoomed image
- s Navigate zoomed image
- t Navigate zoomed image
- u Back to media gallery
- v Played time
- w Recording time
- x Remaining time

## Settings mode

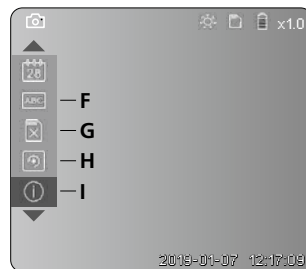
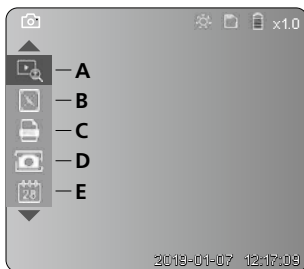

- A Zoom
- B Date and time stamp
- C Image format
- D Image rotation
- E Set date/time
- F Select language
- G Format data medium
- H Factory setting
- I Firmware version

## 1 ON / OFF



## 2 Inserting micro-SD card

To insert a micro-SD card, first open the rubber cover and then insert the memory card as illustrated. You cannot record anything without a storage medium.

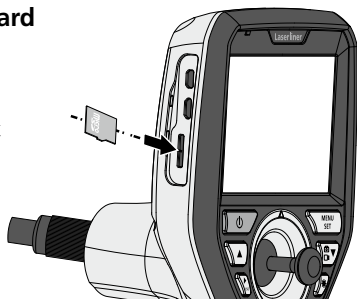

## 3 Settings mode

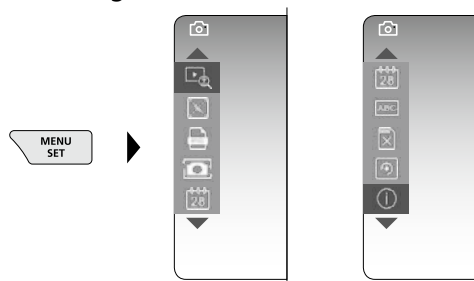

To return to recording mode, press the ESC button (several times).

### a. Zoom

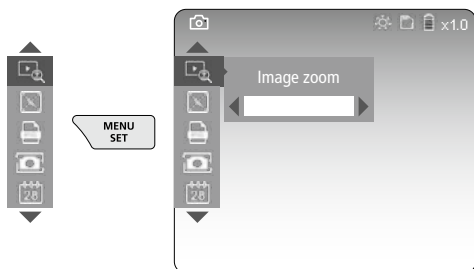

Zoom level 1 ... level 10

### b. Date and time stamp

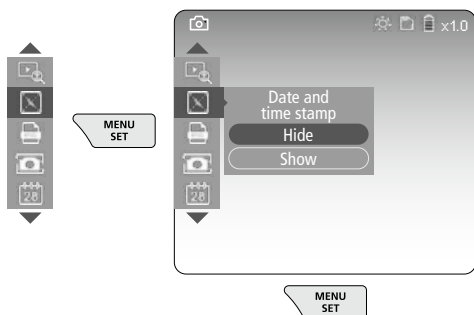

### c. Image format

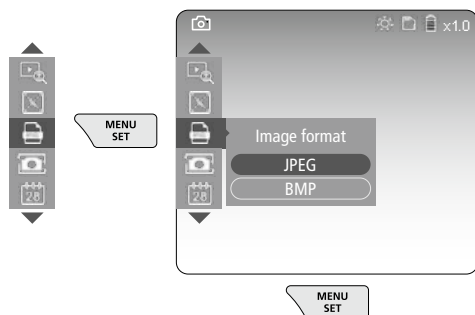



## d. Image rotation

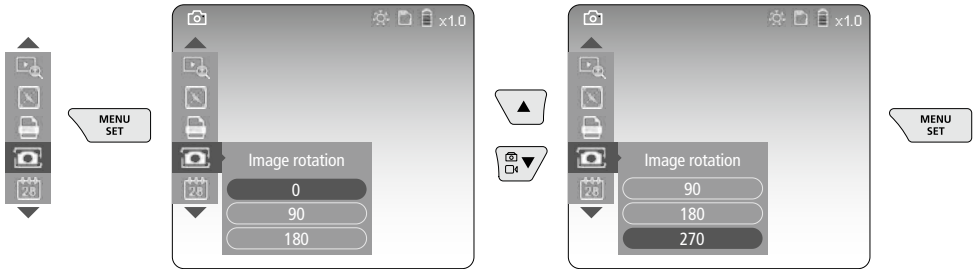

## e. Set date / time

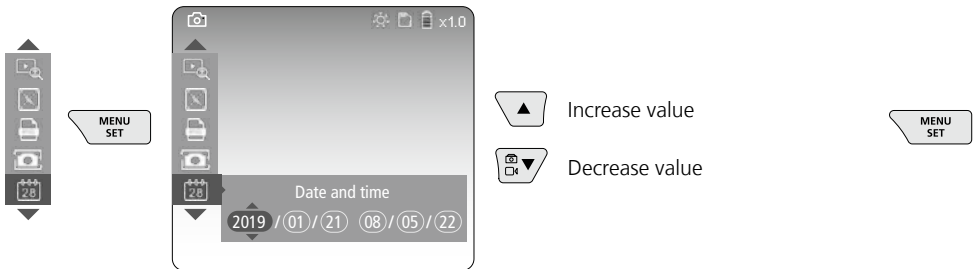

## f. Select language (ZH-CN, ZH-TW, EN, JA, KO, FR, DE, PT, ES, RU, IT, NL)

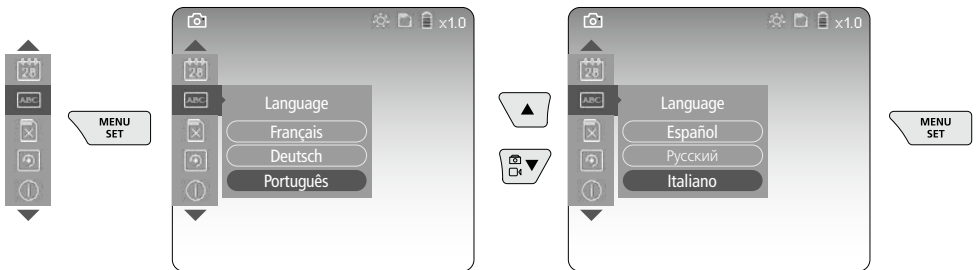

## g. Format data medium

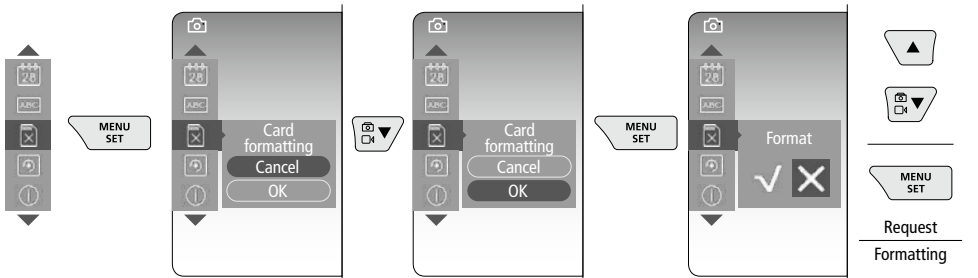

## h. Factory setting

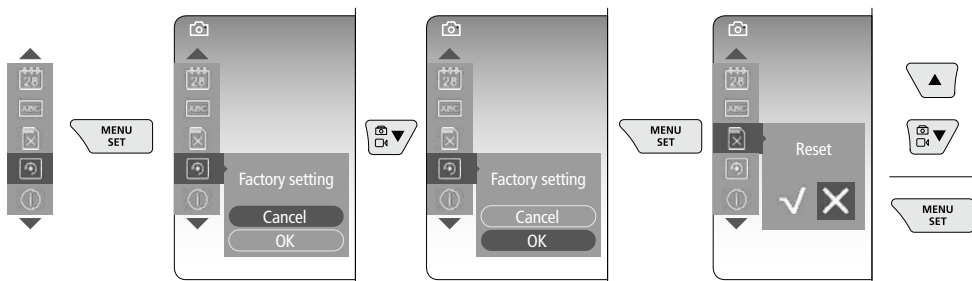

## i. Firmware version / System update

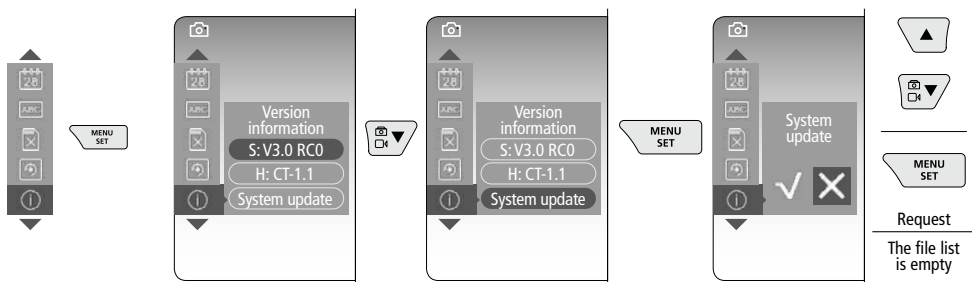

For a system update please contact the UMAREX-LASERLINER Service Department.

## 4 Record mode



### Still images / Video recordings

Guide the camera head on the flexible tubing to the required position and adjust it with the joystick (4). If lighting conditions are poor, switch on the LED lighting. Zoom in on distant or small objects. The manual image rotation function allows the image to be rotated by 90° steps on the display. Briefly press the trigger (9) to take a still image or make a video recording and save it to the SD card. Press the button again to stop the video recording.

## a. Image / video recording selection

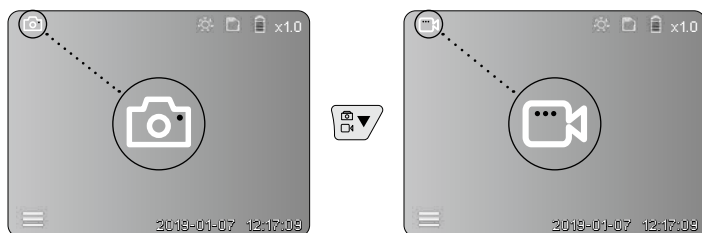

## b. Camera head adjustment

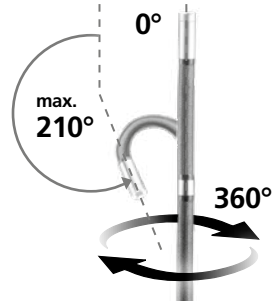
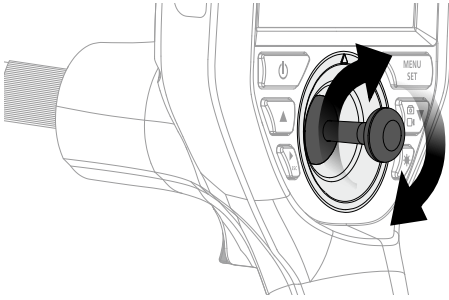

## c. LED lighting

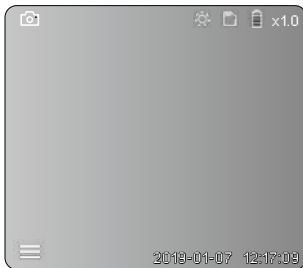

1x		OFF
2x		LED Level 1
3x		LED Level 2
4x		LED Level 3
5x		LED Level 4
6x		LED Level 5
7x		LED Level 6
8x		LED Level 7

## d. Zoom (see section 3 a.)

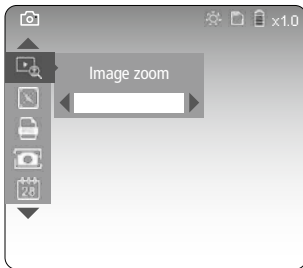

## e. Image rotation

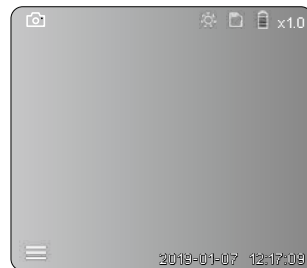

- 1x = Rotation 90°
- 2x = Rotation 90°
- 3x = Rotation 90°
- 4x = Original image

## f. Image / video recording

Briefly press the trigger (9) to take a still image or make a video recording and save it to the SD card. Press the button again to stop the video recording.

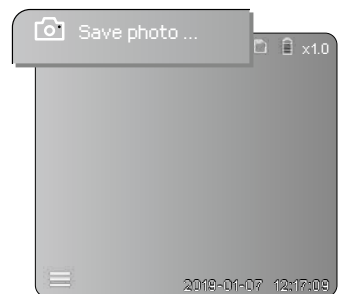
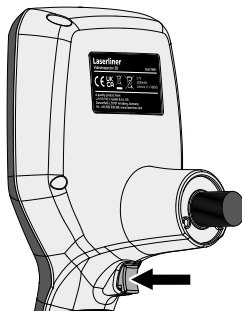

## 5 Playback mode



### Playback of still images / video recordings

Press the „c“ button to call up the media gallery.  
Press the „c“ button again to exit playback mode.

### a. Playing back and deleting image / video recordings

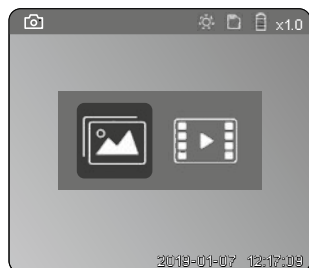
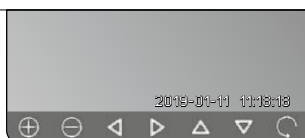
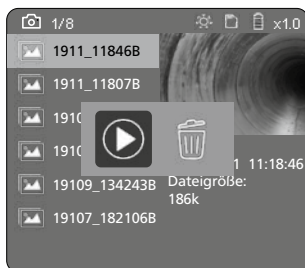
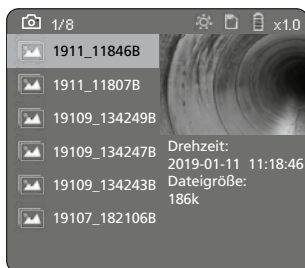

Image / video  
selection



Confirm  
selection

#### Image playback mode



#### Video playback mode

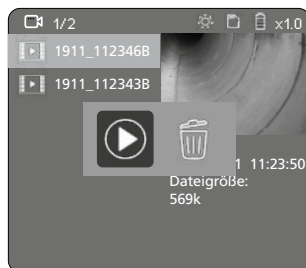
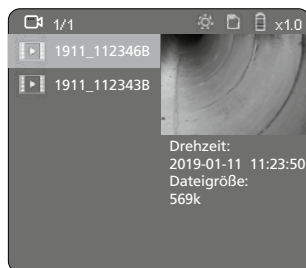

## b. Delete recording

To delete image or video recording, select the image in the media gallery, see section 5 a.



! Deleting cannot be undone.

! All files and folders can be deleted by reformatting the data medium.  
Refer to „3 g. Format Data Medium“.

## USB data transfer

Data saved on the SD card can be transferred to a PC with the supplied card reader.

## Camera head / Focus

The VideInspector 3D delivers sharp images in a range between 2.5 and 10 cm from the camera head.

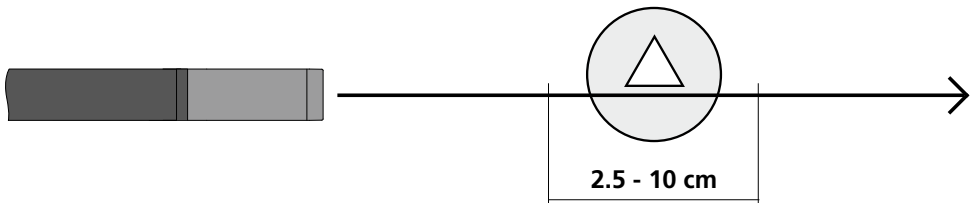

Objects far outside this range may appear blurred.

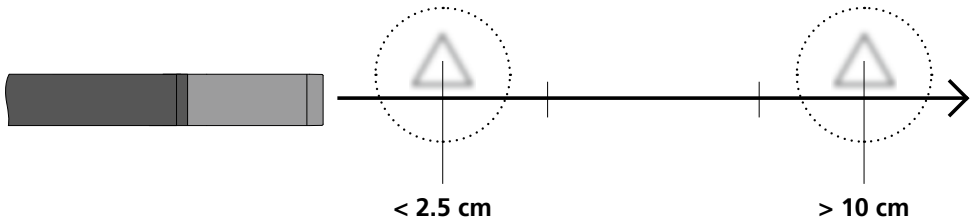

## Changing the battery

Remove magnetic holder, open battery compartment and insert battery as indicated by the installation symbols. Ensure correct polarity.

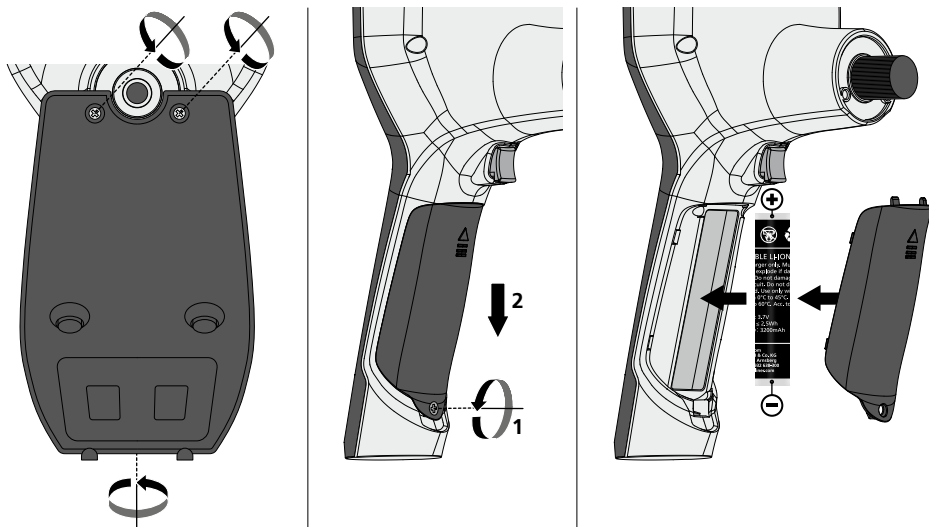

## Connect power supply / battery charger

To charge the device, plug the supplied power supply/charger unit into the micro USB interface/charging socket „6“ and connect it to a corresponding power source.

## Camera unit replacement

The camera unit is easy to remove and replace. Simply undo the screw and pull out the camera unit by the joystick.

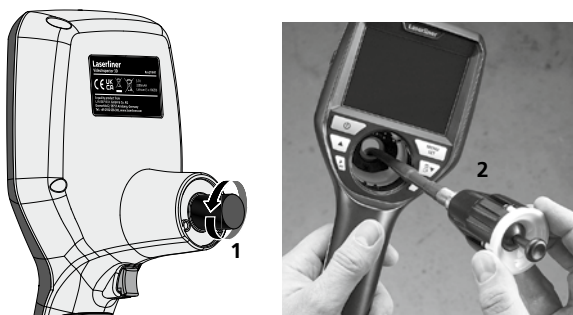

## Danger - powerful magnetic fields

Powerful magnetic fields can adversely affect persons with active medical implants (e.g. pacemaker) as well as electromechanical devices (e.g. magnetic cards, mechanical clocks, precision mechanics, hard disks).

With regard to the effect of powerful magnetic fields on persons, the applicable national stipulations and regulations must be complied with such as BGV B11 §14 „electromagnetic fields“ (occupational health and safety - electromagnetic fields) in the Federal Republic of Germany.

To avoid interference/disruption, always keep the implant or device a safe distance of at least 30 cm away from the magnet.

## Information on maintenance and care

Clean all components with a damp cloth and do not use cleaning agents, scouring agents and solvents. Remove the battery(ies) before storing for longer periods. Store the device in a clean and dry place.

Technical Data		Technical revisions reserved. 21W41
<b>Diameter / Length camera head</b>	ø 6 mm / 74 mm	
<b>Screen type</b>	3.5" TFT colour display	
<b>Display resolution</b>	640 x 480 pixels	
<b>Image format / Video format</b>	JPEG / MP4	
<b>Lighting</b>	7 brightness levels	
<b>Digital zoom</b>	10 zoom levels	
<b>Memory</b>	Micro-SD memory card up to 8 GB	
<b>Protection class</b>	Base unit: IP 54 / Camera probe: IP 68 (immersion depth 1 m, 60 min.)	
<b>Min. bending radius camera probe</b>	75 mm	
<b>Connections</b>	Micro USB, power supply unit 5V/DC	
<b>Camera resolution</b>	960 x 720 pixels	
<b>Field of view (FOV)</b>	85°	
<b>Depth of field (DOF)</b>	2,5 ... 10 cm	
<b>Diameter / Length camera probe</b>	6 mm / 2 m	
<b>Power supply</b>	Li-ion battery pack 3.7V/1.7Ah / power supply unit 5V/DC / 2A	
<b>Operating time</b>	approx. 3.5 h	
<b>Charging time</b>	approx. 4 h	
<b>Operating conditions</b>	-10°C ... 50°C, max. humidity 20 ... 85% rH, no condensation, max. working altitude 4000 m above sea level	
<b>Storage conditions</b>	-20°C ... 60°C, max. humidity 80% rH	
<b>Dimensions (W x H x D)</b>	115 x 190 x 115 mm (not including flexible tubing and holder)	
<b>Weight</b>	485 g (incl. battery pack and flexible tubing / without holder)	

## EU directives and disposal

This device complies with all necessary standards for the free movement of goods within the EU.

This product is an electric device and must be collected separately for disposal according to the European Directive on waste electrical and electronic equipment.

Further safety and supplementary notices at: <http://laserliner.com/info?an=AIH>



! Lees de handleiding, de bijgevoegde brochure 'Garantie- en aanvullende aanwijzingen' evenals de actuele informatie en aanwijzingen in de internet-link aan het einde van deze handleiding volledig door. Volg de daarin beschreven aanwijzingen op. Bewaar deze documentatie en geef ze door als u het apparaat doorgeeft.

## Functie / toepassing

Door middel van een microcamera genereert deze video-inspecteur videobeelden in kleur op het LCD, zodat u moeilijk toegankelijke plekken zoals bijv. holle ruimtes in schachten, muurwerk of de auto kunt controleren.

## Algemene veiligheidsaanwijzingen

- Gebruik het apparaat uitsluitend doelmatig binnen de aangegeven specificaties.
- De meetapparaten en het toebehoren zijn geen kinderspeelgoed. Buiten het bereik van kinderen bewaren.
- De bouwwijze van het apparaat mag niet worden veranderd!
- Stel het apparaat niet bloot aan mechanische belasting, extreme temperaturen, vocht of sterke trillingen.
- Het apparaat mag niet meer worden gebruikt als een of meerdere functies uitvallen of de batterijlading zwak is.
- Let bij gebruik buitenshuis op dat het apparaat alleen onder dienovereenkomstige weersomstandigheden resp. na het treffen van geschikte veiligheidsmaatregelen toegepast wordt.
- De netadapter/het laadtoestel mag alleen in gesloten ruimten gebruikt en niet aan vocht of regen blootgesteld worden omdat anders gevaar voor elektrische schokken bestaat.
- Laad de accu vóór het gebruik van het apparaat compleet op.
- Gebruik uitsluitend het originele toebehoren. Wanneer verkeerd toebehoren worden gebruikt, komt de garantie te vervallen.
- Het laadproces is afgesloten, zodra de bedrijfsindicator groen brandt.
- In geval van een zwakke acculading verschijnt op het display een rood batterijsymbool met een uitroepteken.
- De accu kan ook tijdens het bedrijf worden opgeladen.
- Koppel de netadapter van het net los, wanneer het apparaat niet in gebruik is.
- De LCD-eenheid mag niet onder water worden gedompeld. Het basisapparaat mag niet in contact komen met vloeistoffen.
- De camerakop is niet zuurbestendig en niet vuurvast.
- Let absoluut op dat de VideoInspector 3D niet in contact komt met chemicaliën, stroom, beweeglijke of hete voorwerpen. Hierdoor kan het apparaat beschadigd raken, hetgeen kan leiden tot ernstig persoonlijk letsel van de gebruiker.
- De meetkop kan tijdens het bedrijf zeer heet worden en kwetsbare voorwerpen beschadigen.
- De VideoInspector 3D mag niet worden gebruikt voor medische doeleinden / onderzoek van personen.
- De afdekkap van de aansluitingen moet vast gesloten zijn, zodat de veiligheidsklasse IP 68 gewaarborgd is.
- Neem de veiligheidsvoorschriften van lokale resp. nationale instanties voor het veilige en deskundige gebruik van het apparaat in acht.
- Het apparaat is niet geschikt voor de meting in de buurt van gevaarlijke spanning. Let bij metingen in de buurt van elektrische installaties altijd op de spanningsvrijheid van geleidende onderdelen. De spanningsvrijheid en de beveiliging tegen hernieuwd inschakelen moet door middel van geschikte maatregelen gewaarborgd zijn.

## Veiligheidsinstructies

Omgang met kunstmatige, optische straling OStrV (verordening inzake kunstmatige optische straling)

### Uitree-opening led

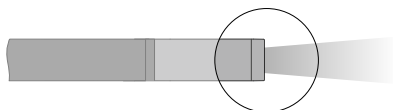



# VideInspector 3D

- Het apparaat werkt met leds uit de risicogroep RG0 (vrij van gevaar) overeenkomstig de geldende normen voor fotobiologische veiligheid (EN 62471:2008-09vv / IEC/TR 62471:2006-07vv) in de telkens actuele lezing.
- De toegankelijke straling van de leds is bij doelmatig gebruik en onder redelijkerwijs te voorziene voorwaarden ongevaarlijk voor het menselijk oog en de menselijke huid.

## Veiligheidsinstructies

Omgang met elektromagnetische straling

- Het meettoestel voldoet aan de voorschriften en grenswaarden voor de elektromagnetische compatibiliteit volgens de EMC-richtlijn 2014/30/EU.

## Veiligheidsinstructies

Omgang met elektromagnetische storingen

- Het meettoestel voldoet aan de voorschriften en grenswaarden voor de veiligheid en de elektromagnetische compatibiliteit conform de richtlijnen 2014/35/EU (laagspanning / LVD) en 2014/30/EU (elektromagnetische compatibiliteit / EMC).
- Plaatselijke gebruiksbeperkingen, bijv. in ziekenhuizen, in vliegtuigen, op pompstations of in de buurt van personen met een pacemaker, moeten in acht worden genomen. Een gevaarlijk effect op of storing van en door elektronische apparaten is mogelijk.

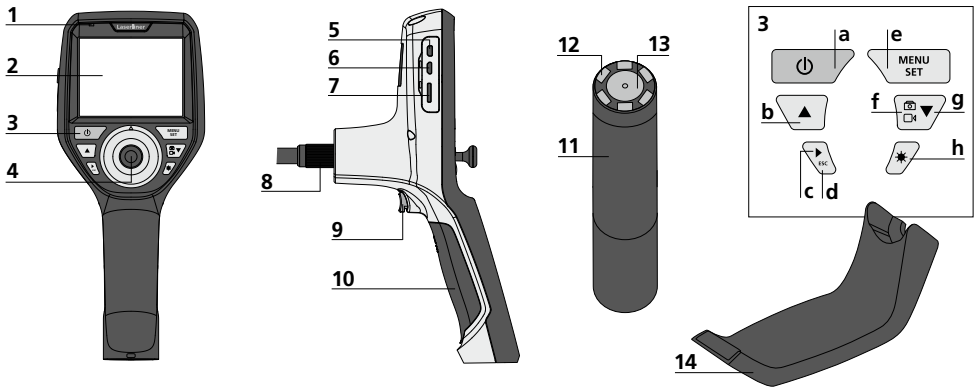

1 Bedrijfsindicator

2 LC-display

3 Directe toetsen

4 Joystick voor de draaiing van de camerakop

5 HDMI-aansluiting

6 Micro-usb-interface / Laadbus

7 Steekplaats micro-SD-kaart

8 Aansluiting flexibele slang

9 Ontspanner

10 Batterijvakje

11 Camerakop

12 Leds

13 Lens

14 Magnetische houder

a ON/OFF / Stilstaand beeld

b Rotatie 180° / Menubesturing

c Mediagalerij beeld / video

d Annuleren

e Instellingsmodus / Bevestigen / Opnames oproepen / Opnames wissen

f Omschakeling beeld / video

g Menubesturing

h LED-verlichting

**OPMERKING:** de VideInspector 3D levert scherpe beelden in het bereik van 2,5 - 10 cm vóórde camerakop. Objecten buiten dit bereik kunnen onscherp worden weergegeven.

## Opnamemodus beeld

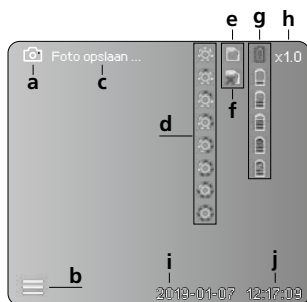

## Opnamemodus video

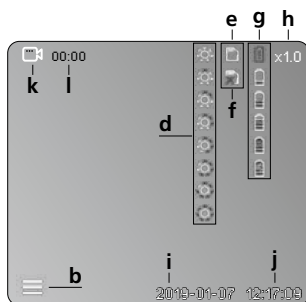

- a Opname beeld
- b Menu gesloten
- c Opslagproces
- d LED-verlichting
- e SD-kaart actief
- f SD-kaart plaatsen
- g Batterijstatus
- h Zoom
- i Actuele datum
- j Actuele tijd
- k Opname video
- l Opname loopt

## Weergavemodus beeld



## Weergavemodus video

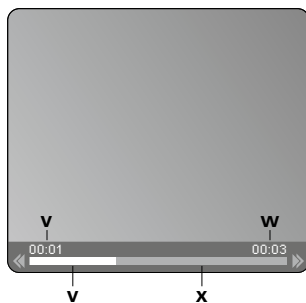

- m Datum van de opname
- n Opnametijd
- o Zoom +
- p Zoom -
- q Navigeren in gezoomd beeld
- r Navigeren in gezoomd beeld
- s Navigeren in gezoomd beeld
- t Navigeren in gezoomd beeld
- u Terug naar de mediagalerij
- v Afgespeelde tijd
- w Duur van de opname
- x Resterende tijd

## Instellingsmodus

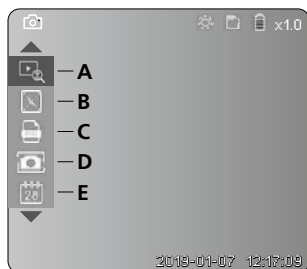

- A Zoom
- B Datum- en tijdstempel
- C Fotoformaat
- D Beeldrotatie
- E Datum / tijd instellen
- F Taal wijzigen
- G Gegevensdrager formatteren
- H Fabrieksinstelling
- I Firmware-versie

## 1 ON / OFF



## 2 Micro SD-kaart plaatsen

Om een micro SD-kaart te plaatsen opent u eerst de rubberen afdekking en plaatst dan de geheugenkaart volgens de afbeelding in de sleuf. Zonder geheugenmedium kunnen geen opnames worden gemaakt.

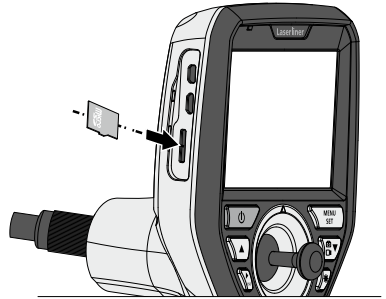

## 3 Instellingsmodus

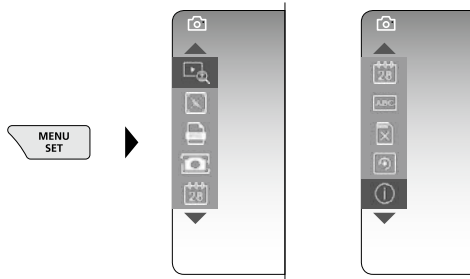

Druk (meerdere malen) op de ESC-toets om weer naar de opnamemodus te schakelen.

### a. Zoom

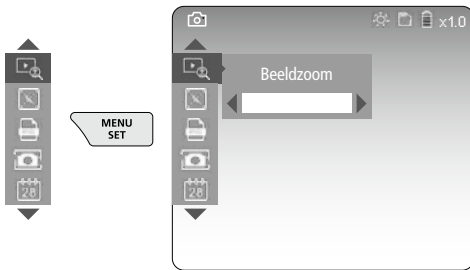

Zoom niveau 1 ... niveau 10

### b. Datum- en tijdstempel

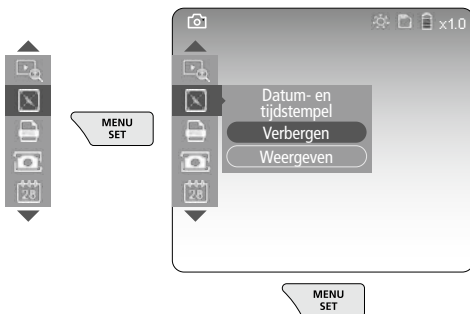

### c. Fotoformaat

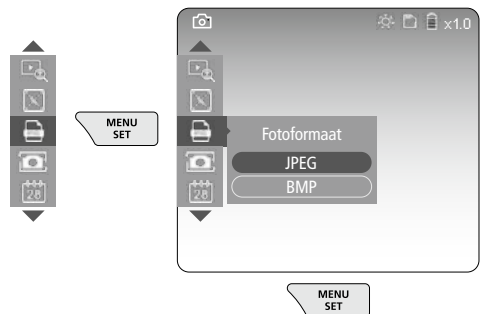

## d. Beeldrotatie

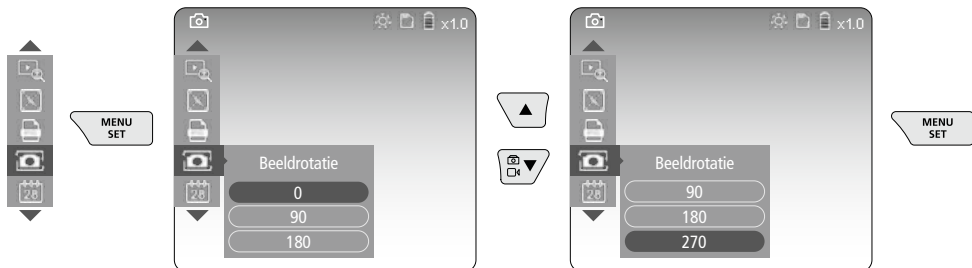

## e. Datum / tijd instellen

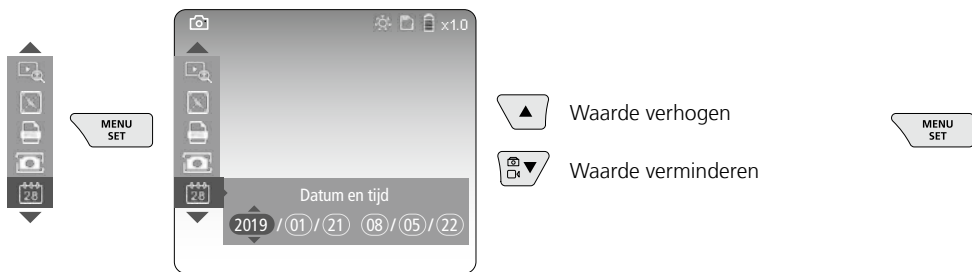

## f. Taal wijzigen (ZH-CN, ZH-TW, EN, JA, KO, FR, DE, PT, ES, RU, IT, NL)

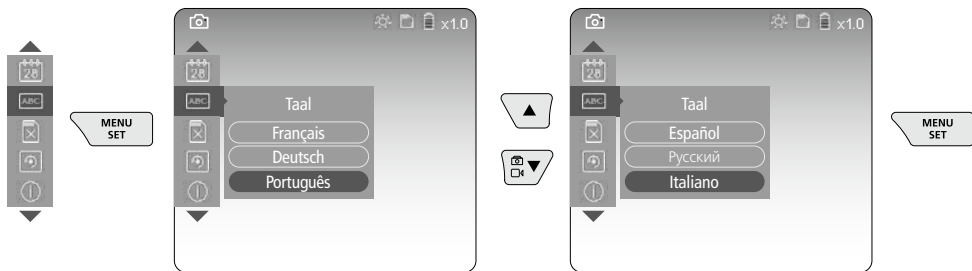

## g. Gegevensdrager formatteren

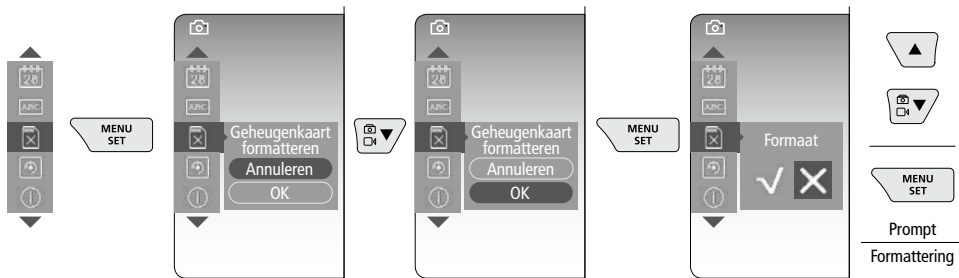

## h. Fabrieksinstelling

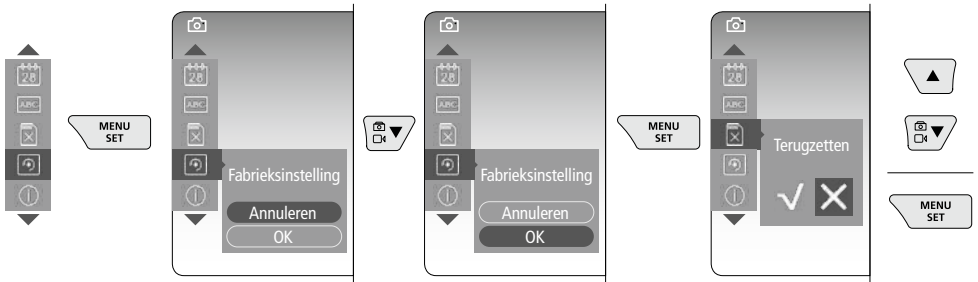

## i. Firmware-versie / Systemupdate

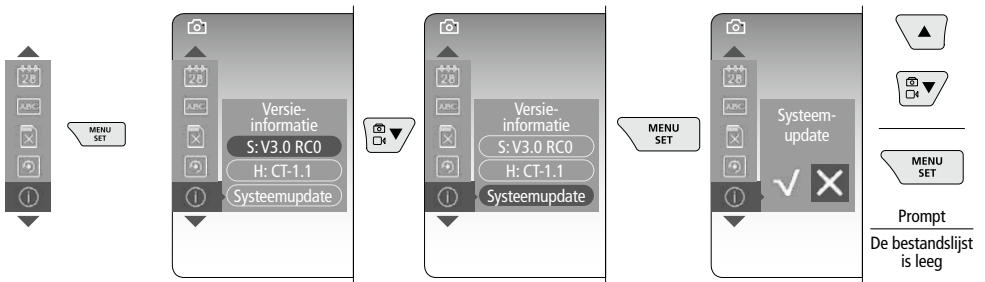

Neem voor de uitvoering van een systeemupdate contact op met de serviceafdeling van UMAREX-LASERLINER.

## 4 Opnamemodus

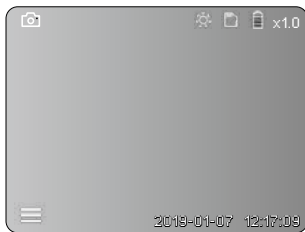

### Beeld-/video-opnames

Beweeg de camerakop aan de flexibele slang naar de gewenste positie en lijn hem uit met de joystick (4). Schakel de LED-verlichting in geval van slechte lichtomstandigheden in. U kunt kleine objecten of objecten op afstand dichterbij halen (zoomen). Het beeld op de monitor kan met behulp van de handmatige beeldrotatie in stappen van 90° worden gedraaid. Druk kort op de ontspanner (9) om de foto te maken en op de SD-kaart op te slaan of de video-opname te starten. Druk opnieuw op de ontspanner om de video-opname te stoppen en op te slaan.

### a. Omschakeling opname beeld / video

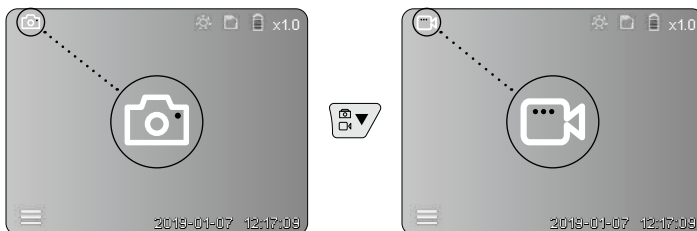

## b. Uitlijnen van de camerakop

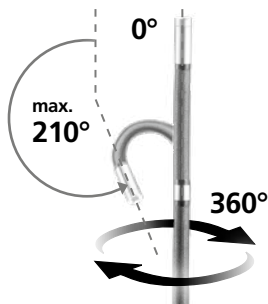
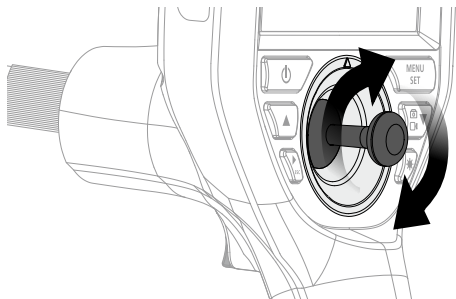

## c. LED-verlichting

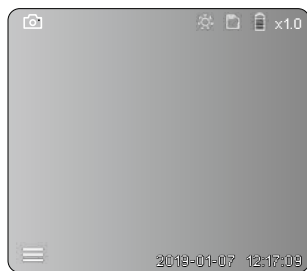

1x		UIT
2x		LED stand 1
3x		LED stand 2
4x		LED stand 3
5x		LED stand 4
6x		LED stand 5
7x		LED stand 6
8x		LED stand 7

## d. Zoom (zie hoofdstuk 3a)

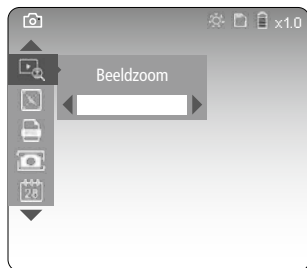

## e. Beeldrotatie

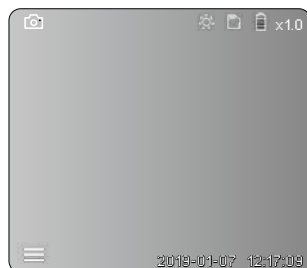

- 1x = Draaiing 90°
- 2x = Draaiing 90°
- 3x = Draaiing 90°
- 4x = Uitgangsbild

## f. Opname beeld / video

Druk kort op de ontspanner (9) om de foto te maken en op de SD-kaart op te slaan of de video-opname te starten. Druk opnieuw op de ontspanner om de video-opname te stoppen en op te slaan.

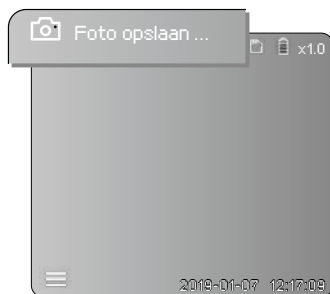
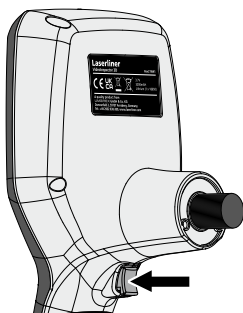

## 5 Weergavemodus



### Weergave van beeld-/video-opnames

Druk op de toets ‚c‘ om de mediagalerij op te roepen. Druk opnieuw op de toets ‚c‘ om de weergavemodus te sluiten.

### a. Afspelen en wissen van foto-/video-opnames

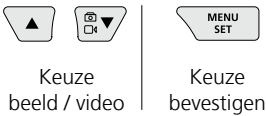
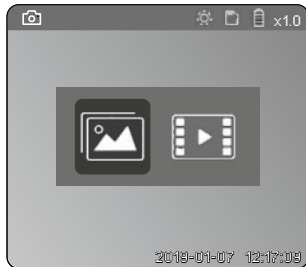

#### Weergavemodus beeld

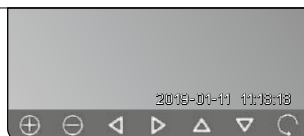
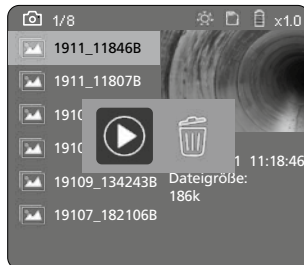
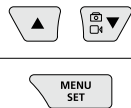
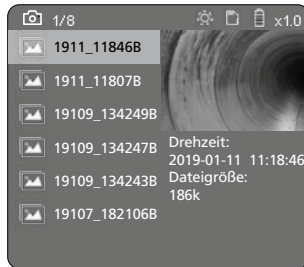

#### Weergavemodus video

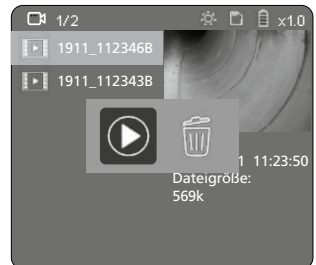
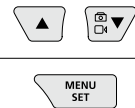
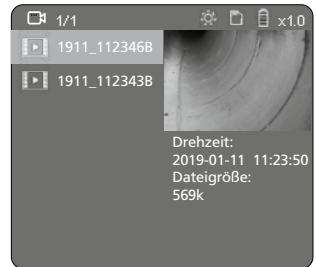

## b. Opname wissen

Voor het wissen van een foto- of video-opname, roept u de foto / video in de mediagalerij op, zie hoofdstuk 5 a.

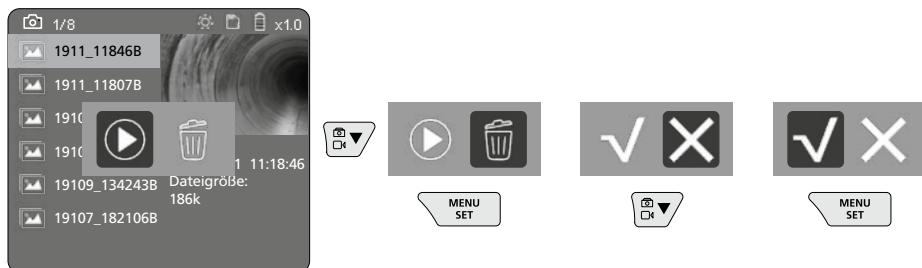

! Het wisproces kan niet ongedaan worden gemaakt.

! Via de formattering van de gegevensdrager kunnen alle bestanden en mappen worden gewist. Zie hiervoor punt ,3 g. Gegevensdrager formatteren'.

## USB-gegevensoverdracht

De opgeslagen gegevens op de SD-kaart kunnen met de bijgeleverde kaartlezer naar de pc worden overgedragen.

## Camerakop / focus

De Videolnspector 3D levert scherpe beelden in het bereik van 2,5 - 10 cm vóór de camerakop.

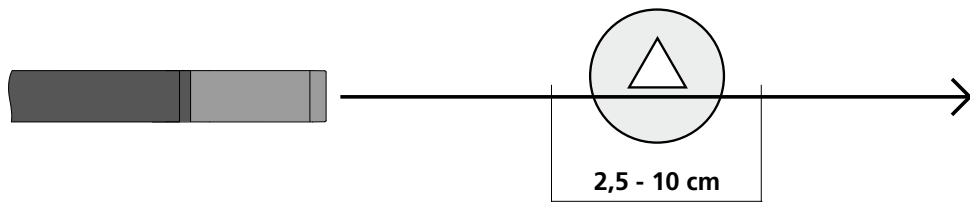

Objecten die ver buiten dit bereik liggen, kunnen onscherp worden weergegeven.

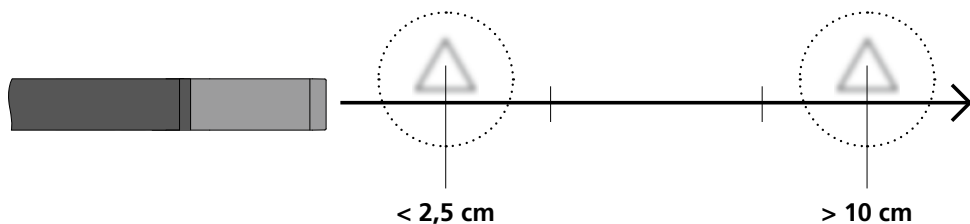



## Vervangen van de accu

Verwijder de magnetische houder, open het accuvakje en plaats de accu overeenkomstig de symbolen. Let daarbij op de juiste polariteit.

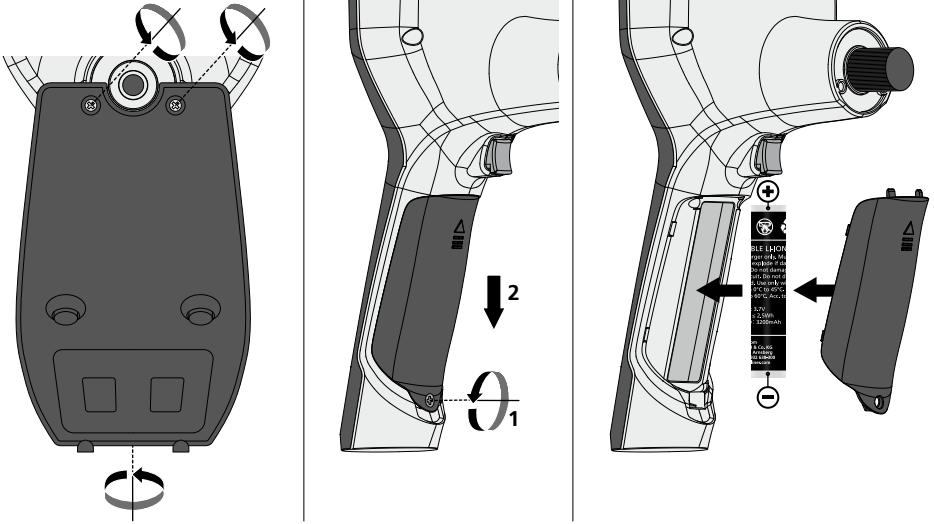

## Net-/laadtoestel aansluiten

Sluit de bijgeleverde netadapter/het laadtoestel aan op de micro USB-aansluiting / laadbus ,6' en verbind hem met een dienovereenkomstige stroombron om het toestel op te laden.

## Vervangen van de camera-eenheid

De camera-eenheid kan eenvoudig worden verwijderd en vervangen. Draai daarvoor de schroef los en trek de camera-eenheid aan de joystick eruit.

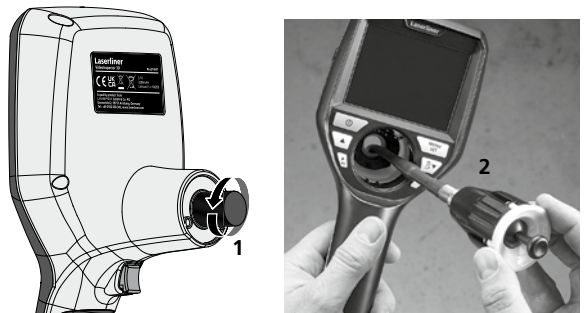

## Gevaar door krachtige magnetische velden

Krachtige magnetische velden kunnen schadelijke invloeden hebben op personen met actieve implantaten (bijv. pacemakers) alsmede op elektromechanische apparaten (bijv. magneetkaarten, mechanische horloges, fijne mechanische apparatuur, harde schijven).

Met het oog op het effect van krachtige magnetische velden op personen dienen de desbetreffende nationale bepalingen en voorschriften te worden nageleefd, in de Bondsrepubliek Duitsland bijvoorbeeld het voorschrift van de wettelijke ongevallenverzekering BGV B11 §14 „Elektromagnetische Felder“ (elektromagnetische velden).

Om storende effecten te voorkomen, dient u de magneten altijd op een afstand van ten minste 30 cm van de bedreigde implantaten en apparaten te houden.

## Opmerkingen inzake onderhoud en reiniging

Reinig alle componenten met een iets vochtige doek en vermijd het gebruik van reinigings-, schuur- en oplosmiddelen. Verwijder de batterij(en) voordat u het apparaat gedurende een langere tijd niet gebruikt. Bewaar het apparaat op een schone, droge plaats.

Technische gegevens		Technische wijzigingen voorbehouden. 21W41
<b>Diameter / Lengte camerakop</b>	ø 6 mm / 74 mm	
<b>Beeldschermtype</b>	3,5" TFT-kleurendisplay	
<b>Resolutie display</b>	640 x 480 pixel	
<b>Fotoformaat / videoformaat</b>	JPEG / MP4	
<b>Verlichting</b>	7 helderheidsstanden	
<b>Digitale zoom</b>	10 zoomniveaus	
<b>Geheugen</b>	Micro-SD geheugenkaart tot 8 GB	
<b>Beschermingsklasse</b>	Basiseenheid: IP 54 / Camera-sonde: IP 68 (Duikdiepte 1 m, 60 min.)	
<b>Min. buigradius camera-sonde</b>	75 mm	
<b>Aansluitingen</b>	Micro-USB, netadapter 5V / DC	
<b>Resolutie camera</b>	960 x 720 pixel	
<b>Zichtveld (FOV)</b>	85°	
<b>Scherpte-diepte-bereik (DOF)</b>	2,5 ... 10 cm	
<b>Diameter / Lengte Sonde</b>	6 mm / 2 m	
<b>Voeding</b>	Li-ion accupak 3,7 V / 1,7 Ah / netadapter 5 V/DC / 2A	
<b>Bedrijfsduur</b>	ca. 3,5 uur	
<b>Laadtijd</b>	ca. 4 uur	
<b>Werkomstandigheden</b>	-10°C ... 50°C, luchtvochtigheid max. 20 ... 85% rH, niet-condenserend, werkhoogte max. 4000 m boven NAP (Nieuw Amsterdams Peil)	
<b>Opslagvoorwaarden</b>	-20°C ... 60°C, luchtvochtigheid max. 80% rH	
<b>Afmetingen (B x H x D)</b>	115 x 190 x 115 mm (zonder flexibele slang en houder)	
<b>Gewicht</b>	485 g (incl. accupak en flexibele slang / zonder houder)	

## EU-bepalingen en afvoer

Het apparaat voldoet aan alle van toepassing zijnde normen voor het vrije goederenverkeer binnen de EU.

Dit product is een elektrisch apparaat en moet volgens de Europese richtlijn voor oude elektrische en elektronische apparatuur gescheiden verzameld en afgevoerd worden.

Verdere veiligheids- en aanvullende instructies onder: <http://laserliner.com/info?an=AIH>





Du bedes venligst læse betjeningsvejledningen, det vedlagte hæfte „Garanti- og supplerende anvisninger“ samt de aktuelle oplysninger og henvisninger på internetlinket i slutning af denne vejledning fuldstændigt igennem. Følg de heri indeholdte instrukser. Dette dokument skal opbevares og følge med apparatet, hvis dette overdrages til en ny ejer.

## Funktion / anvendelse

Denne video-inspektor leverer farve-videobilleder ved hjælp af et mikrokamera på LCD-skærmen til kontrol af vanskeligt tilgængelige steder som fx hulrum, skakter, murværk eller i køretøjer.

## Almindelige sikkerhedshenvisninger

- Apparatet må kun bruges til det tiltænkte anvendelsesformål inden for de givne specifikationer.
- Måleapparaterne og tilbehøret er ikke legetøj. Skal opbevares utilgængeligt for børn.
- Konstruktionsmæssigt må apparatet ikke ændres.
- Undgå at udsætte apparatet for mekaniske belastninger, meget høje temperaturer, fugt eller kraftige vibrationer.
- Apparatet må ikke anvendes længere, hvis en eller flere funktioner svigter, eller hvis batteriladningen er svag.
- Ved udendørs brug må udstyret kun anvendes under passende vejrforhold og/eller ved brug af egnede beskyttelsesforanstaltninger.
- Strømforsyningen/opladeren må kun bruges i lukkede rum; må ikke udsættes for fugt eller regn, da der ellers er risiko for elektrisk stød.
- Inden apparatet tages i brug, skal batterierne lades helt op.
- Brug kun originalt tilbehør. Hvis der anvendes forkert tilbehør, bortfalder garantien.
- Ladeprocessen er færdig, når driftsindikatoren lyser grønt.
- Når batteriladningen bliver svag, vises der et rødt batterisymbol med et udråbstegn på displayet.
- También se puede cargar la batería durante el funcionamiento.
- Disconnect the power pack from the mains when the device is not in use.
- Lysdiodeenheden må ikke dyppes ned i vand. Basisapparatet må ikke komme i kontakt med væske.
- Kamerahovedet er ikke syrebestandigt eller ildfast.
- Det er vigtigt, at man sørger for, at VideInspector 3D ikke kommer i kontakt med kemikalier, spænding, bevægelige eller varme genstande. Dette kan ødelægge apparatet og desuden medføre alvorlige personskader på operatøren.
- Målehovedet kan blive meget varmt under drift og medføre skader på følsomt materiale, der skal måles.
- VideInspector 3D må ikke anvendes til medicinske undersøgelser/personundersøgelser.
- For at kunne garantere beskyttelsesklasse IP 68 skal tilslutningernes afdækningskappe være lukket ordentligt.
- Iagttag sikkerhedsforanstaltningerne fra lokale og/eller nationale myndigheder med henblik på saglig korrekt brug af apparatet.
- Apparatet er ikke beregnet til måling i nærheden af farlig spænding. Derfor skal man altid sikre sig, at der ikke er spænding i ledende dele, når man foretager målinger i nærheden af elektriske anlæg. Den spændingsfri tilstand og sikring mod genstart skal sikres med passende foranstaltninger.

## Sikkerhedsanvisninger

Omgang med kunstig, optisk stråling OStrV

### Udgangsåbnings-LED

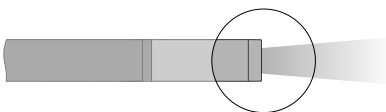

- Apparatet bruger LED'er i risikogruppen RG 0 (fri gruppe, ingen risiko) i henhold til gældende standarder for fotobiologisk sikkerhed (EN 62471:2008-09ff / IEC/TR 62471:2006-07ff) i de nuværende udførelser.
- Den tilgængelige stråling fra LED'erne er ved tilsigtet anvendelse og under rimeligt forudsigelige forhold ufarlig for det menneskelige øje og den menneskelige hud.

## Sikkerhedsanvisninger

Omgang med elektromagnetisk stråling

- Måleapparatet overholder forskrifterne og grænseværdierne for elektromagnetisk kompatibilitet iht. EMC-direktiv 2014/30/EU.

## Sikkerhedsanvisninger

Håndtering af elektromagnetisk interferens

- Måleren overholder de sikkerhedsmæssige og elektromagnetiske kompatibilitetsbestemmelser og grænseværdier iht. 2014/35/EU (lavspænding / LVD) og 2014/30/EU (elektromagnetisk kompatibilitet / EMC).
- Lokale anvendelsesrestriktioner, f.eks. på hospitaler, i fly eller i nærheden af personer med pacemaker, skal iagttages. Risikoen for farlig påvirkning eller fejl i eller pga. elektronisk udstyr er til stede.

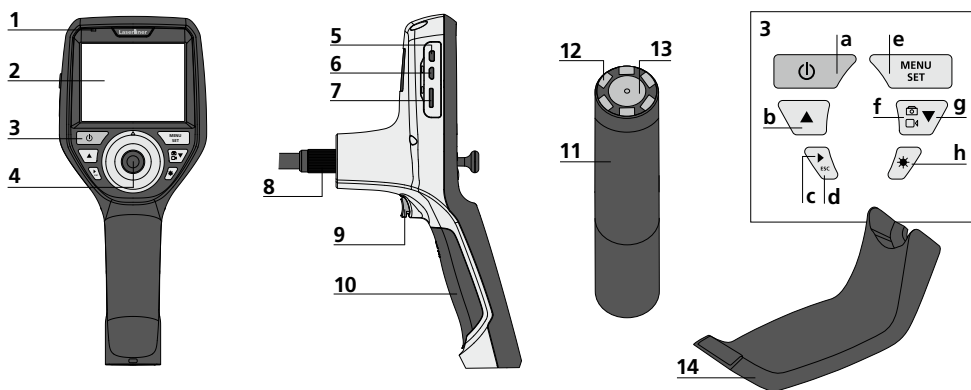

- |  |                          |   |                              |
|--|--------------------------|---|------------------------------|
| 1 Driftsindikator                            | 7 Slot Mikro SD-kort     | a ON/OFF / Stillbillede   | f Omstilling billede / video |
| 2 LC-display                                 | 8 Tilslutning flexslange | b Rotation 180° / Menustyring                                     | g Menustyring                |
| 3 Direkt-knapper                             | 9 Udløser                | c Mediegalleri billede / video                                    | h Diodelampe                 |
| 4 Styrehåndtag til drejning af kamerahovedet | 10 Batterikammer         | d Afbryd  |                              |
| 5 HDMI-interface                             | 11 Kamerahoved           | e Indstillingsmodus / Bekræft / Hent optagelser / Slet optagelser |                              |
| 6 Mikro-USB-interface / Ladestik             | 12 LED's (lysdioder)     |   |                              |
|  | 13 Linse                 |   |                              |
|  | 14 Magnetholder          |   |                              |

**BEMÆRK:** Videolinspector 3D giver skarpe billeder i området 2,5 - 10 cm foran kamerahovedet. Objekter, der ligger langt uden for dette område, kan forekomme uskarpe.

## Optagelsesmodus billede

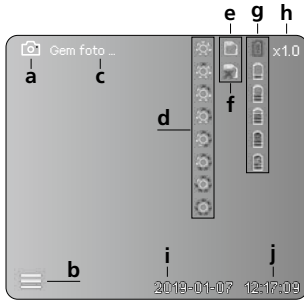

## Optagelsesmodus video

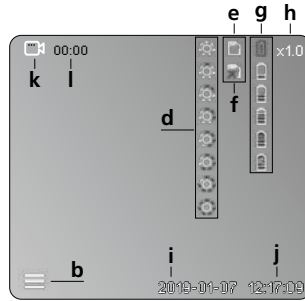

- a Optagelse billede
- b Menu lukket
- c Lagringsproces
- d Diodelampe
- e SD-kort aktivt
- f Indsæt SD-kort
- g Batteristatus
- h Zoom
- i Aktuel dato
- j Aktuelt klokkeslæt
- k Optagelse video
- l Optagelse i gang

## Gengivelsesmodus billede

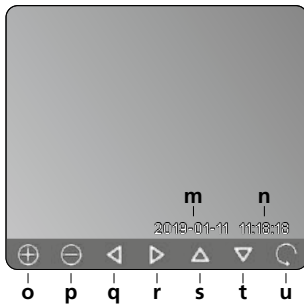

## Gengivelsesmodus video

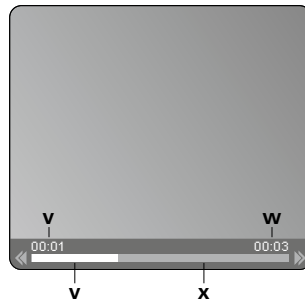

- m Optagelsesdato
- n Optagetid
- o Zoom +
- p Zoom -
- q Navigering af indzoomet billede
- r Navigering af indzoomet billede
- s Navigering af indzoomet billede
- t Navigering af indzoomet billede
- u Tilbage til mediegalleri
- v Afspillet tid
- w Optagelsestid
- x Resterende tid

## Indstillingsmodus

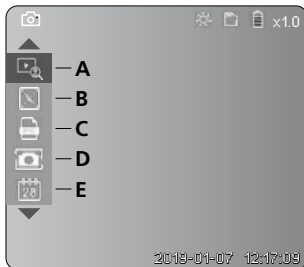

- A Zoom
- B Dato- og tidsstempel
- C Billedformat
- D Billedrotation
- E Indstilling af dato/klokkeslæt
- F Skift sprog
- G Formatér datamedium
- H Fabriksindstilling
- I Firmware-version

## 1 ON / OFF



## 2 Indsæt mikro-SD-kort

Man indsætter et mikro-SD-kort ved først at åbne gummiafdækningen og dernæst indsætte hukommelseskortet som vist i figuren. Uden hukommelsesmedium kan optagelser ikke gemmes.

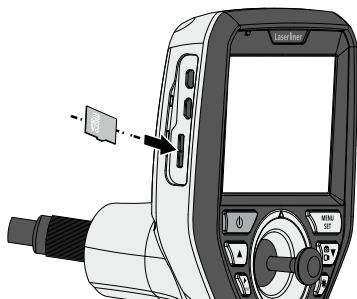

## 3 Indstillingsmodus

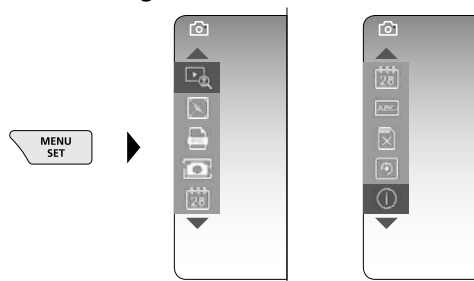

Man kommer tilbage til optagelsesmodus ved at trykke (gentagne) gange på knappen ESC.

### a. Zoom

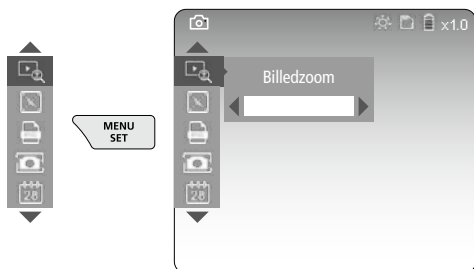

Zoom trin 1 ... trin 10

### b. Dato- og tidsstempel

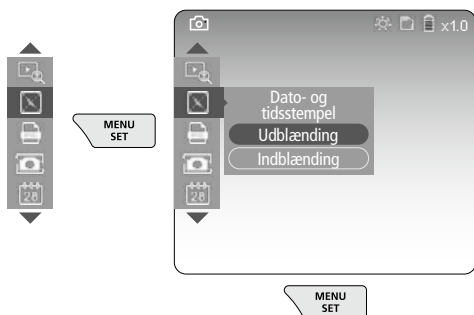

### c. Billedformat

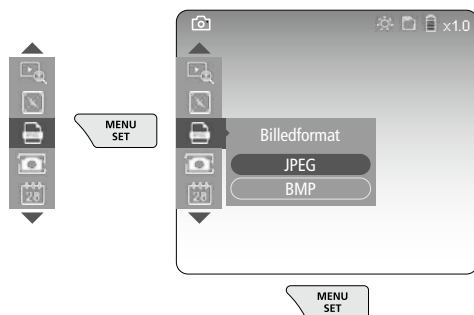

## d. Billedrotation

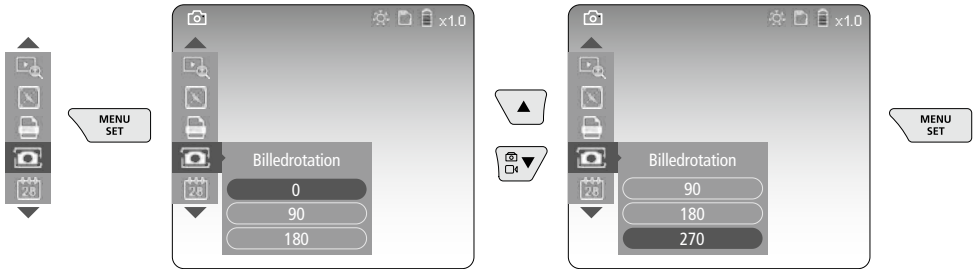

## e. Indstilling af dato / klokkeslæt

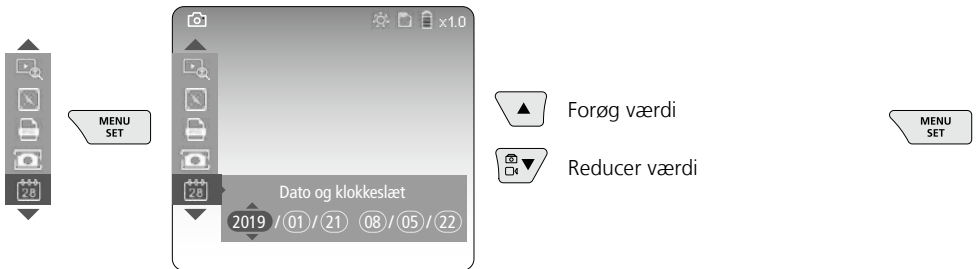

## f. Skift sprog (ZH-CN, ZH-TW, EN, JA, KO, FR, DE, PT, ES, RU, IT, NL)

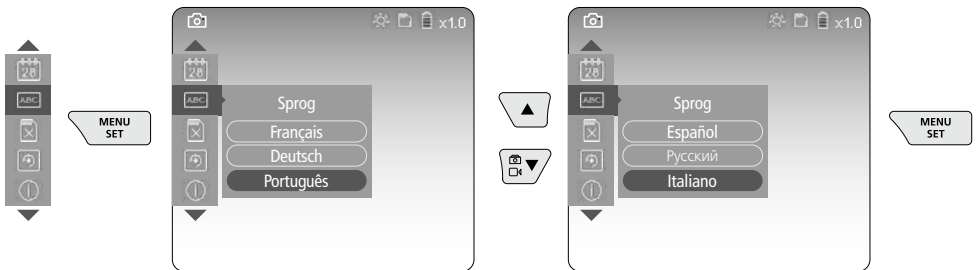

## g. Formatér datamedium

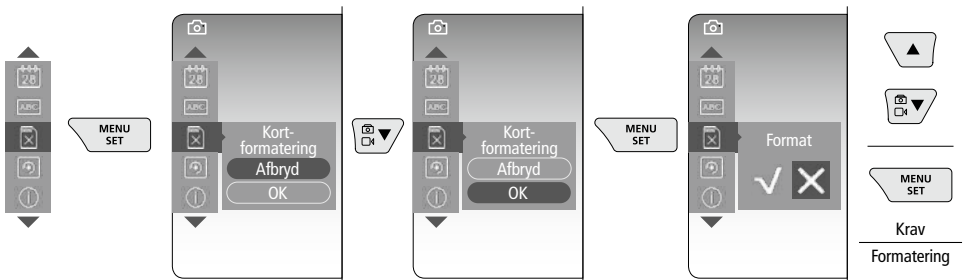

## h. Fabriksindstilling

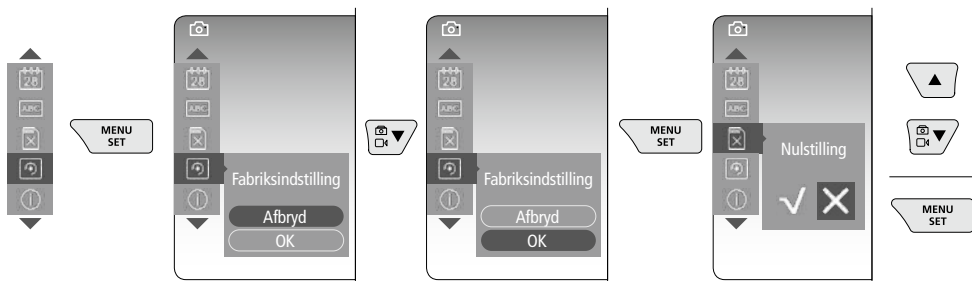

## i. Firmware-version / Systemopdatering

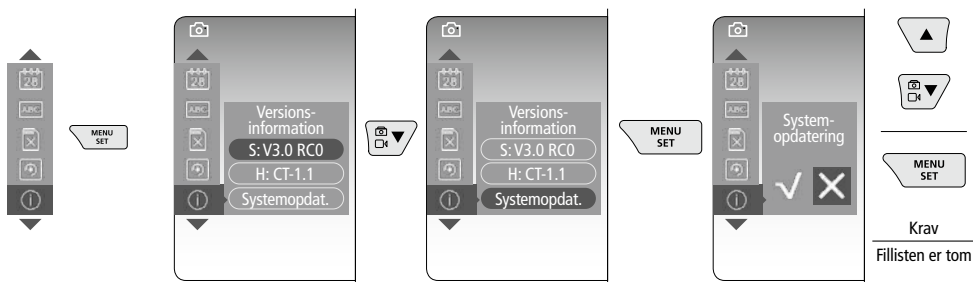

**!** For at udføre en systemopdatering skal du kontakte serviceafdelingen hos UMAREX-LASERLINER.

## 4 Optagelsesmodus



### Billed-/videooptagelse

Flyt kamerahovedet til den ønskede position på flexslangen, og indjuster det med styrehåndtaget (4). Under dårlige lysforhold kan man tænde diodelampen. Man kan zoome ind på fjerne eller små objekter. Via den manuelle billedrotation kan billedet drejes i 90°-trin på monitoren. Når man trykker kortvarigt på udløseren (9), optages billedet eller videoen og gemmes på SD-kortet. Videooptagelsen afsluttes ved at trykke på udløseren igen.

### a. Skift mellem billede / video

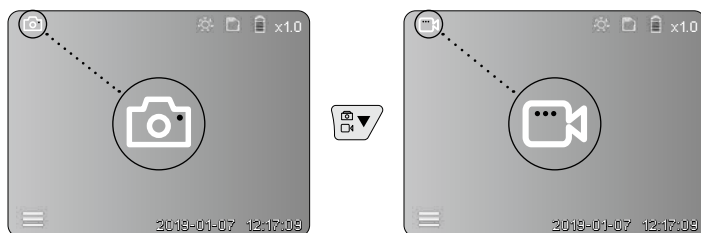



## b. Indjustering af kamerahovedet

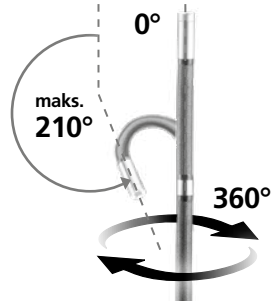
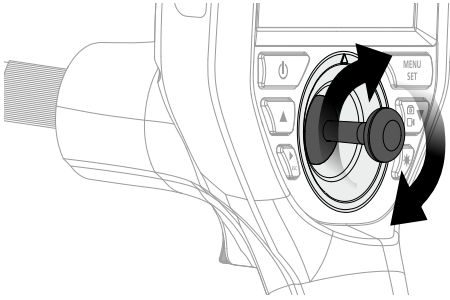

## c. Diodelampe

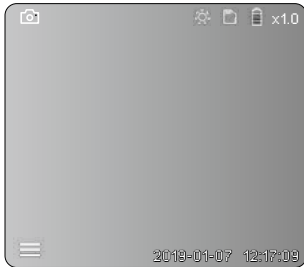

1x		FRA
2x		LED Trin 1
3x		LED Trin 2
4x		LED Trin 3
5x		LED Trin 4
6x		LED Trin 5
7x		LED Trin 6
8x		LED Trin 7

## d. Zoom (se afsnit 3 a.)

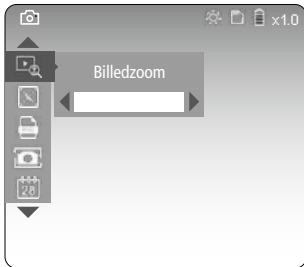

## e. Billedrotation

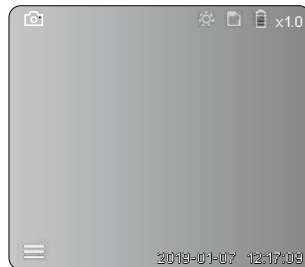

1x = Spejling 90°

2x = Spejling 90°

3x = Spejling 90°

4x = Udgangs-  
billede

## f. Optagelse billede / video

Når man trykker kortvarigt på udløseren (9), optages billedet eller videoen og M15:M89 på SD-kortet. Videooptagelsen afsluttes ved at trykke på udløseren igen.



## 5 Gengivelsesmodus



### Gengivelse af billed-/videooptagelser

Når man trykker på knappen „c“, indhentes mediegalleriet.  
Når man trykker endnu en gang på knappen „c“, lukkes gengivelsesmodus.

### a. Gengivelse og sletning af billed-/videooptagelser

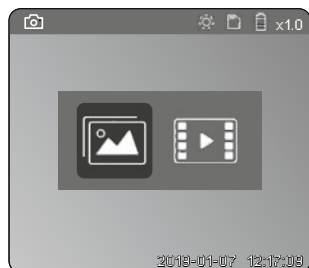

Valg af  
billede / video



Bekræft  
valg

#### Gengivelsesmodus billede

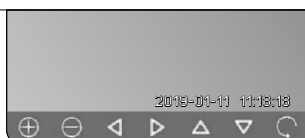
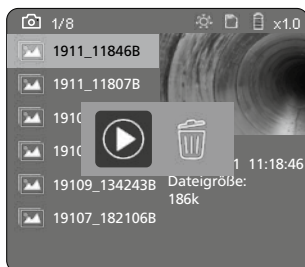
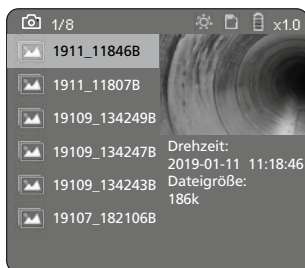

#### Gengivelsesmodus video

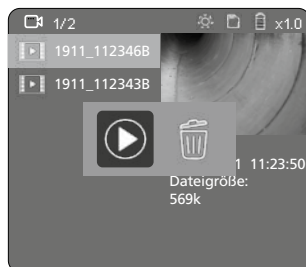
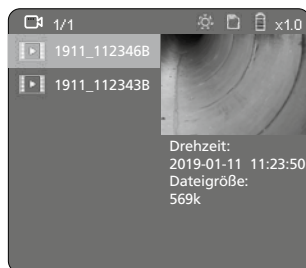

## b. Slet optagelse

For at slette en billed- eller en videooptagelse skal du hente billedet i mediegalleriet, se afsnit 5 a.

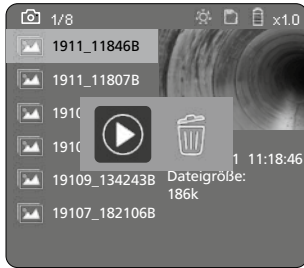

MENU  
SET



MENU  
SET



Sletteprocessen kan ikke fortrydes.



Via formatering af datamedierne kan man slette alle filer og mapper.  
Se punkt „3 g. Formatér datamedium“.

## USB-dataoverførsel

De lagrede data på SD-kortet kan overføres til pc'en med den medfølgende kortlæser.

## Kamerahoved/-fokus

VideInspector 3D giver skarpe billeder i området 2,5 - 10 cm foran kamerahovedet.

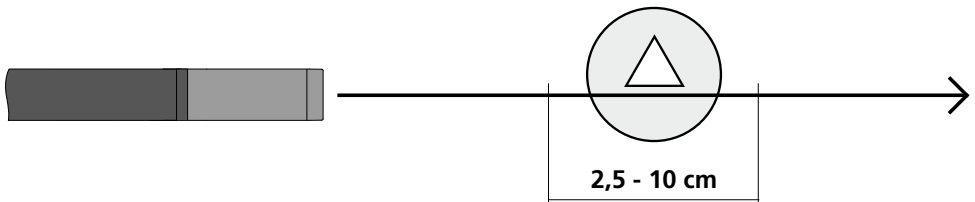

Objekter, der ligger langt uden for dette område, kan forekomme uskarpe.

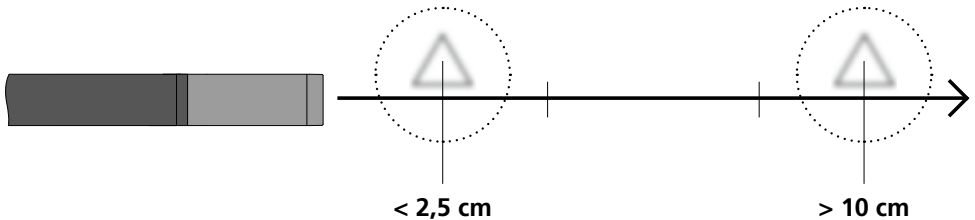

## Udskiftning af batterier

Fjern magnetholderen, åbn batterirummet, og indsæt batteriet i henhold til installationssymbolerne. Vær opmærksom på korrekt polaritet.

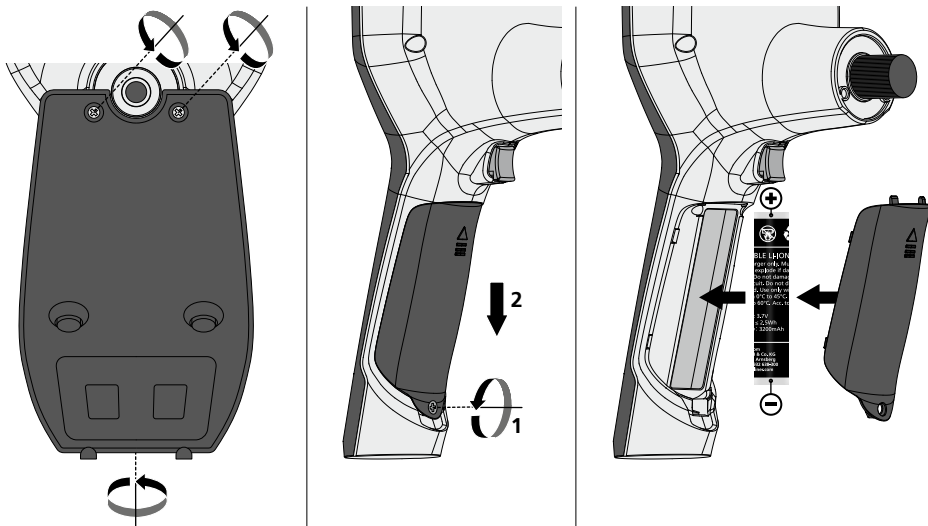

## Tilslutning af lysnetoplader

Når apparatet skal oplades, tilslutter man den medfølgende lysnetadapter/oplader til mikro-USB-interfacet / ladestikket „6“ og forbinder den med en passende strømkilde.

## Udskiftning af kameraenheden

Kameraenheden kan nemt udtages og udskiftes. Dette gøres ved at løsne skruen og trække kameraenheden å styrehåndtaget ud.

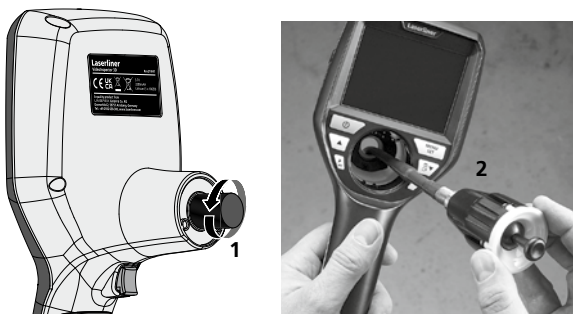

## Fare pga. stærke magnetfelter

Stærke magnetfelter kan have skadelige virkninger på personer med implantater (fx pacemakere) og på elektromekaniske apparater (fx magnetkort, mekaniske ure, finmekanik, harddiske).

Med hensyn til stærke magnetfelters virkning på personer skal man iagttage de relevante nationale regler og bestemmelser; dette vil fx i Tyskland sige brancheforeningens forskrift BGV B11 §14 „Elektromagnetiske felter“.

For at undgå generende påvirkninger skal man altid holde magneterne i en afstand på mindst 30 cm fra enhver form for følsomme implantater og apparater.

## Anmærkninger vedr. vedligeholdelse og pleje

Alle komponenter skal rengøres med en let fugtet klud, og man skal undlade brug af rengørings-, skure- og opløsningsmidler. Batterierne skal tages ud inden længere opbevaringsperioder. Apparatet skal opbevares på et rent og tørt sted.

Technische Daten		Technische Änderungen vorbehalten. 21W41
<b>Diameter / Længde Kamerahoved</b>	ø 6 mm / 74 mm	
<b>Skærmtype</b>	3,5" TFT-farvedisplay	
<b>Opløsning display</b>	640 x 480 pixel	
<b>Billedformat / videoformat</b>	JPEG / MP4	
<b>Belysning</b>	7 lysstyrketrin	
<b>Digital zoom</b>	10 zoomtrin	
<b>Hukommelse</b>	Mikro-SD-kort op til 8 GB	
<b>Beskyttelsesmåde</b>	Grundenhed: IP 54 / Kamera-sonde: IP 68 (Dykningsdybde 1 m, 60 min.)	
<b>Min. bukkeradius kamera-sonde</b>	75 mm	
<b>Tilslutninger</b>	Mikro-USB, adapter 5V / DC	
<b>Opløsning kamera</b>	960 x 720 pixel	
<b>Synsfelt (FOV)</b>	85°	
<b>Dybdeskarphe (DOF)</b>	2,5 ... 10 cm	
<b>Diameter / Længde kamera-sonde</b>	6 mm / 2 m	
<b>Strømforsyning</b>	Li-ion-batteripakke 3,7V / 1,7Ah / adapter 5V/DC / 2A	
<b>Driftstid</b>	ca. 3,5 timer	
<b>Ladetid</b>	ca. 4 timer	
<b>Arbejdsbetingelser</b>	-10°C ... 50°C, luftfugtighed maks. 20 ... 85% rH, ikke-kondenserende, arbejdshøjde maks. 4000 m.o.h.	
<b>Opbevaringsbetingelser</b>	-20°C ... 60°C, luftfugtighed maks. 80% rH	
<b>Mål (B x H x D)</b>	115 x 190 x 115 mm (uden flexslange og holder)	
<b>Vægt</b>	485 g (inkl. batteripakke og flexslange / uden holder)	

## EU-bestemmelser og bortskaffelse

Apparatet opfylder alle påkrævede standarder for fri vareomsætning inden for EU.

Dette produkt er et elapparat og skal indsamles og bortskaffes separat i henhold til EF-direktivet for (brugte) elapparater.

Flere sikkerhedsanvisninger og supplerende tips på: <http://laserliner.com/info?an=AIH>



! Lisez entièrement le mode d'emploi, le carnet ci-joint « Remarques supplémentaires et concernant la garantie » et les renseignements et consignes présentés sur le lien Internet précisé à la fin de ces instructions. Suivez les instructions mentionnées ici. Conservez ces informations et les donner à la personne à laquelle vous remettez l'instrument.

## Fonction / Utilisation

Cet appareil d'inspection vidéo fournit des images vidéo en couleur grâce à une microcaméra qui envoie les informations à l'écran ACL afin de contrôler des endroits très difficiles d'accès, tels que des cavités, des puits, des murs ou dans des véhicules.

## Consignes de sécurité générales

- Utiliser uniquement l'instrument pour l'emploi prévu dans le cadre des spécifications.
- Les appareils et les accessoires ne sont pas des jouets. Les ranger hors de portée des enfants.
- Il est interdit de modifier la construction de l'instrument.
- Ne pas soumettre l'appareil à une charge mécanique, ni à des températures extrêmes ni à de l'humidité ou à des vibrations importantes.
- Ne plus utiliser l'instrument lorsqu'une ou plusieurs fonction(s) ne fonctionne(nt) plus ou lorsque le niveau de charge de la pile est bas.
- Faire attention lors de l'utilisation à l'extérieur à n'utiliser l'appareil que dans les conditions météorologiques adéquates et/ou en prenant les mesures de sécurité appropriées.
- N'utiliser le chargeur / l'appareil secteur que dans des pièces fermées, ne les exposer ni à l'humidité ni à la pluie car il y a sinon un risque de décharge électrique.
- Avant utilisation, recharger complètement l'accu de l'appareil.
- Utiliser uniquement des accessoires d'origine. Le droit à la garantie expire en cas d'utilisation d'accessoires inappropriés.
- Le processus de charge est terminé lorsque le témoin de fonctionnement s'allume en vert.
- Un symbole rouge indiquant une pile et un point d'exclamation s'affiche dès que la charge de la pile rechargeable est faible.
- Il est également possible de charger l'accu pendant le fonctionnement de l'appareil.
- Débrancher le bloc d'alimentation électrique du secteur lorsque l'appareil n'est pas utilisé.
- Ne pas plonger l'écran ACL dans l'eau. L'appareil de base ne doit pas entrer en contact avec des liquides.
- La tête de la caméra ne résiste pas aux acides ni au feu.
- Il est indispensable de faire attention à ce que le VideoInspector 3D n'entre pas en contact avec des produits chimiques, la tension ou encore des pièces brûlantes ou en mouvement. Cela peut endommager l'appareil et provoquer de graves blessures chez l'utilisateur.
- La tête de mesure peut fortement chauffer pendant le fonctionnement et endommager ainsi l'objet à mesurer sensible.
- Il est interdit d'utiliser le VideoInspector 3D pour des examens médicaux / effectués sur des personnes.
- Le capuchon des raccords doit être parfaitement fermé afin de garantir la catégorie de protection IP 68.
- Prière de tenir compte des mesures de sécurité de l'administration locale et/ou nationale relative à l'utilisation correcte de l'appareil.
- L'appareil ne convient pas à la mesure à proximité d'une tension dangereuse. C'est pourquoi, il faut toujours faire attention à l'absence de tension des pièces conductrices en cas de mesures à proximité d'installations électriques. Garantir l'absence de tension et l'impossibilité de toute remise sous tension en prenant les mesures nécessaires.

## Consignes de sécurité

Utilisation avec des rayonnements optiques artificiels (OStrV - décret de protection du travail relatif aux rayonnements optiques artificiels)

### Orifice de sortie de la DEL

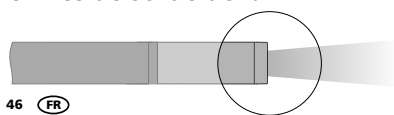

- L'appareil fonctionne avec des DEL du groupe de risques RG 0 (groupe libre, pas de risque) conformément aux normes en vigueur pour la sécurité photobiologique (EN 62471:2008-09 et suiv. / CEI/TR 62471:2006-07 et suiv.) dans leurs versions actuelles.
- L'émission accessible des DEL est inoffensive pour l'œil humain et la peau de l'homme en cas d'utilisation conforme à la destination prévue et dans des conditions raisonnablement prévisibles.

## Consignes de sécurité

Comportement à adopter lors de rayonnements électromagnétiques

- L'appareil de mesure respecte les prescriptions et les valeurs limites de compatibilité électromagnétique conformément à la directive CEM 2014/30/UE.

## Consignes de sécurité

Utilisation avec des perturbations électromagnétiques

- L'appareil de mesure est conforme aux directives et aux valeurs limites en matière de sécurité et de compatibilité électromécanique selon les directives 2014/35/UE (directive sur la basse tension / LVD) et 2014/30/UE (compatibilité électromagnétique / EMV).
- Il faut tenir compte des restrictions des activités par ex. dans les hôpitaux, les avions, les stations-services ou à proximité de personnes portant un stimulateur cardiaque. Les appareils électroniques peuvent être la source ou faire l'objet de risques ou de perturbations.

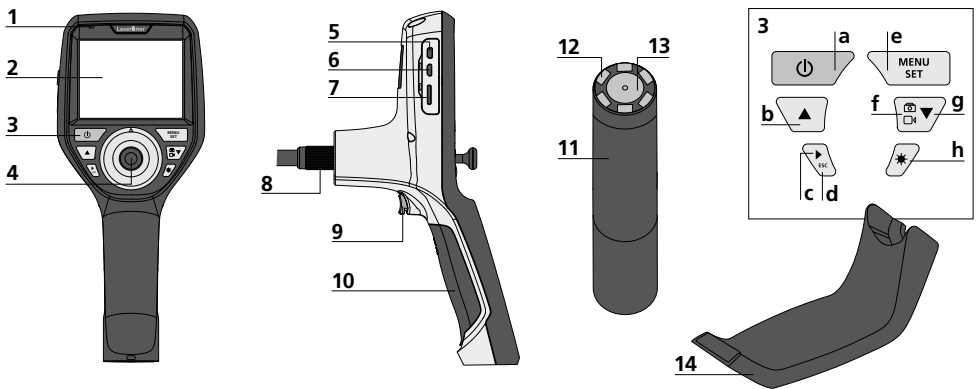

- |  |                             |   |                             |
|--|-----------------------------|---|-----------------------------|
| 1 DEL de fonctionnement                            | 7 Slot carte micro-SD       | a ON/OFF / Image figée  | f Commutation image / vidéo |
| 2 Affichage à cristaux liquides                    | 8 Raccord du tuyau flexible | b Rotation 180° / Commande des menus  | g Commande des menus        |
| 3 Touches directes                                 | 9 Déclencheur               | c Galerie média image / vidéo   | h Éclairage DEL             |
| 4 Joystick pour faire tourner la tête de la caméra | 10 Compartiment à piles     | d Annuler   |                             |
| 5 Interface HDMI                                   | 11 Tête de la caméra        | e Mode de réglage / Validation / Sélectionner enregistrements / Effacer les enregistrements |                             |
| 6 Interface micro USB / Prise de charge            | 12 DEL's                    |   |                             |
|  | 13 Lentille                 |   |                             |
|  | 14 Fixation magnétique      |   |                             |

**REMARQUE :** VideInspector 3D fournit des images nettes à une distance comprise entre 2,5 - 10 cm devant la tête de la caméra. Les objets situés au-delà de cette zone peuvent apparaître en flou.

## Mode d'enregistrement image

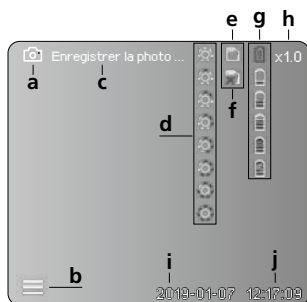

## Mode d'enregistrement vidéo

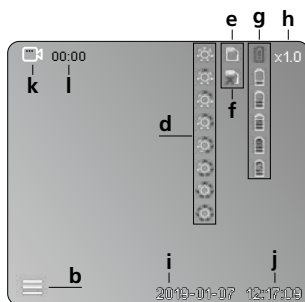

- a Enregistrement photo
- b Menu fermé
- c Processus de sauvegarde
- d Éclairage DEL
- e Carte SD active
- f Introduire la carte SD
- g État de charge des piles
- h Zoom
- i Date actuelle
- j Heure actuelle
- k Enregistrement vidéo
- l Enregistrement en cours

## Mode de lecture image

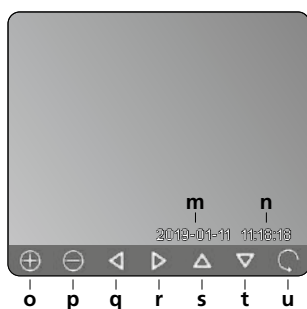

## Mode de lecture vidéo

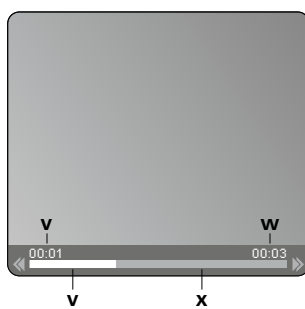

- m Date d'enregistrement
- n Durée d'enregistrement
- o Zoom +
- p Zoom -
- q Naviguer dans la photo agrandie
- r Naviguer dans la photo agrandie
- s Naviguer dans la photo agrandie
- t Naviguer dans la photo agrandie
- u Retour à la vue d'ensemble des médias
- v Durée écoulée
- w Durée d'enregistrement
- x Durée restante

## Mode de réglage

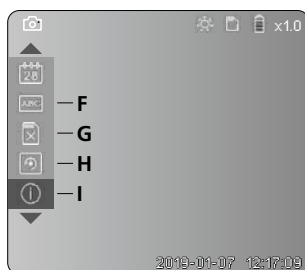
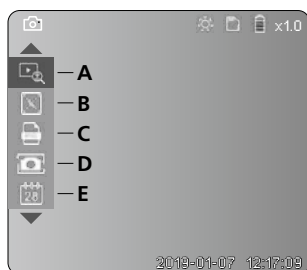

- A Zoom
- B Dateur et horodateur
- C Format de l'image
- D Rotation de l'image
- E Réglage date/heure
- F Changer la langue
- G Formater support de données
- H Réglage usine
- I Version du micrologiciel



## 1 ON / OFF



## 2 Introduction de la micro carte SD

Pour introduire une micro carte SD, ouvrez tout d'abord le couvercle en caoutchouc, puis placez la carte de mémoire comme illustrée. Aucun enregistrement n'est possible sans support de mémorisation.

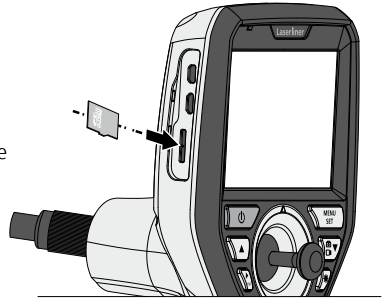

## 3 Mode de réglage

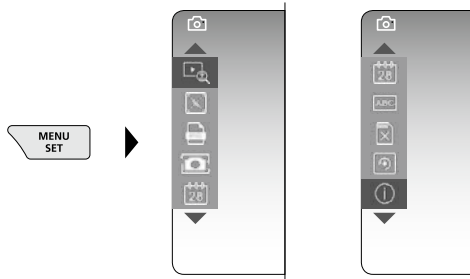

Pour revenir au mode d'enregistrement, appuyez (plusieurs) fois sur la touche ESC.

### a. Zoom

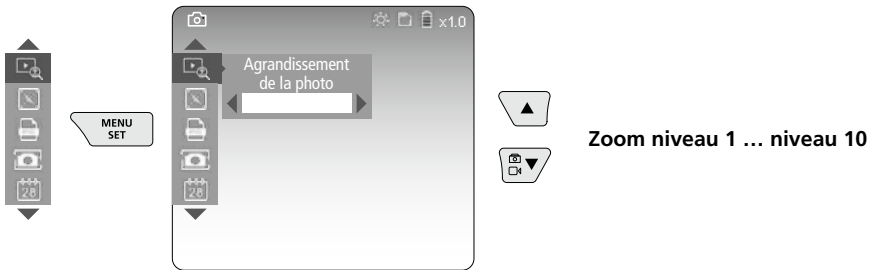

### b. Dateur et horodateur

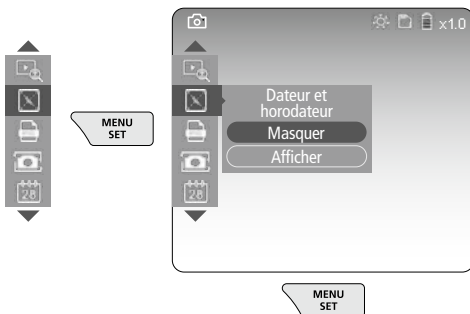

### c. Format de la photo

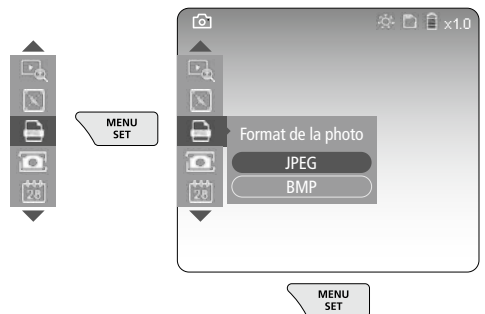

## d. Rotation de l'image

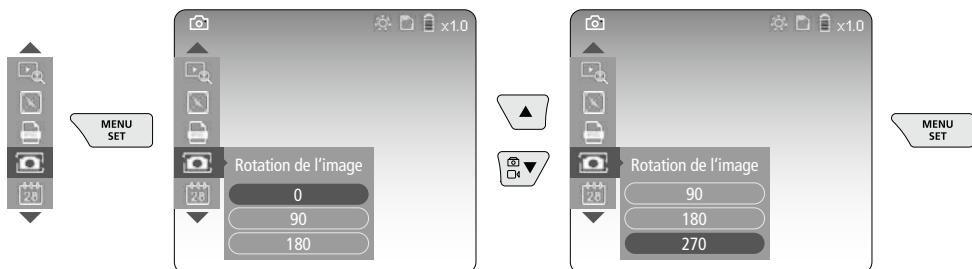

## e. Réglage date / heure

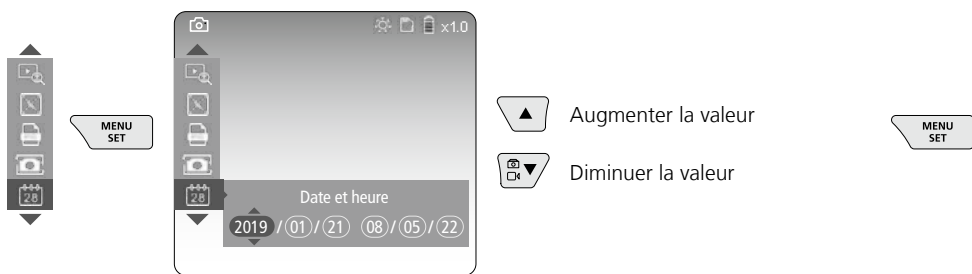

## f. Changer la langue (ZH-CN, ZH-TW, EN, JA, KO, FR, DE, PT, ES, RU, IT, NL)

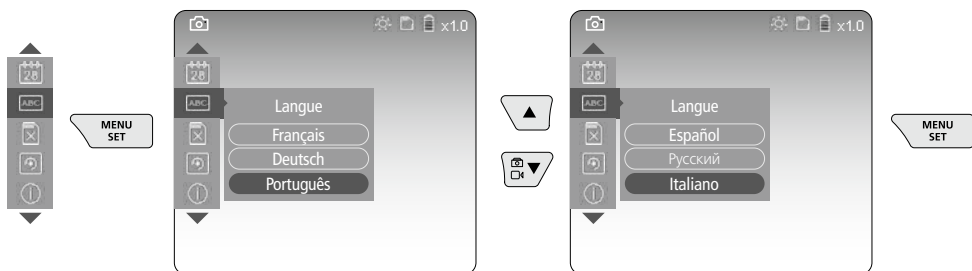

## g. Formater support de données

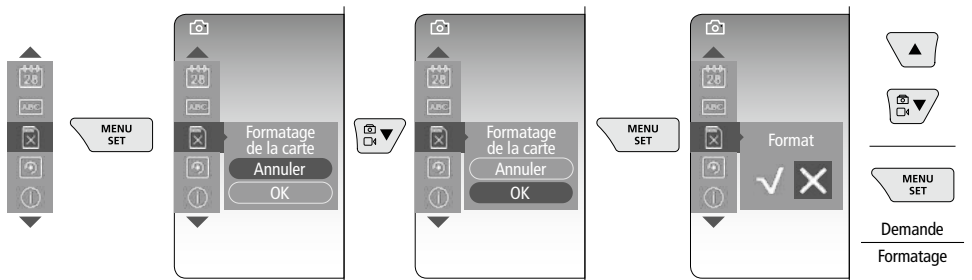

## h. Réglage usine

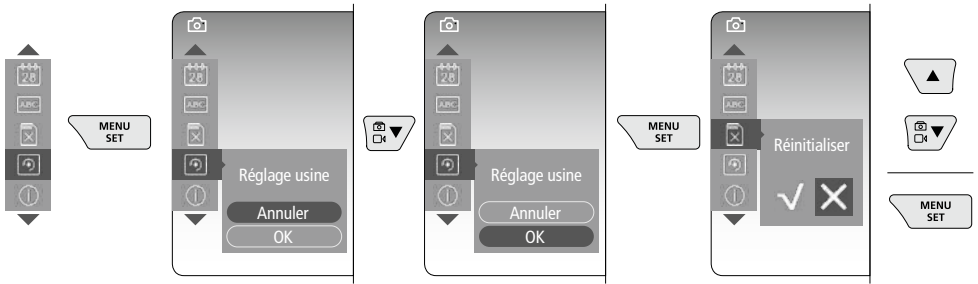

## i. Version du micrologiciel / Mise à jour du système

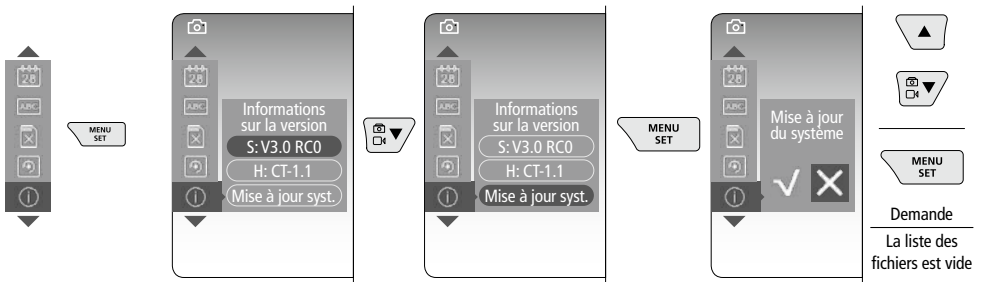

Adressez-vous au service après-vente de la société UMAREX-LASERLINER pour réaliser une mise à jour du système.

## 4 Mode d'enregistrement

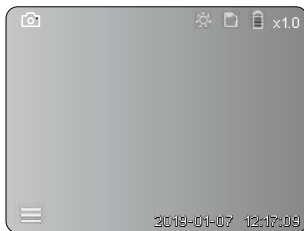

### Enregistrement d'images / vidéo

Orienter la tête de la caméra située sur le tuyau flexible à la position souhaitée en utilisant le joystick (4). Activer l'éclairage DEL en cas de mauvaise visibilité. Zoomer sur des objets de petite taille ou éloignés. La rotation manuelle de l'image permet de faire tourner l'image par pas de 90° sur le moniteur. Actionner brièvement le bouton de déclenchement (9) pour enregistrer la photo ou l'enregistrement vidéo et la/le mémoriser sur la carte SD. Un nouvel actionnement met fin à l'enregistrement.

## a. Commutation enregistrement image / vidéo

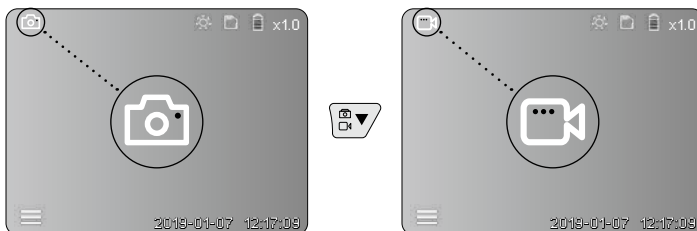

## b. Orientation de la tête de la caméra

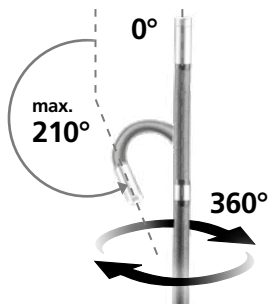
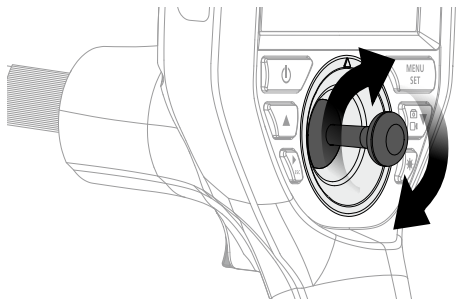

## c. Éclairage DEL

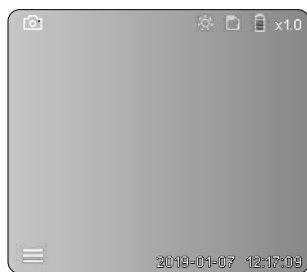

1x		ARRÊT
2x		DEL niveau 1
3x		DEL niveau 2
4x		DEL niveau 3
5x		DEL niveau 4
6x		DEL niveau 5
7x		DEL niveau 6
8x		DEL niveau 7

## d. Zoom (voir le chapitre 3 a.)

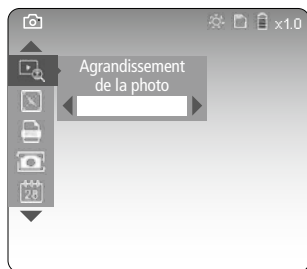

## e. Rotation de l'image

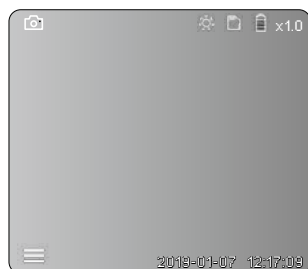

- 1x = Rotation de 90°
- 2x = Rotation de 90°
- 3x = Rotation de 90°
- 4x = Image initiale

## f. Enregistrement image / vidéo

Actionner brièvement le bouton de déclenchement (9) pour enregistrer la image ou l'enregistrement vidéo et la/le mémoriser sur la carte SD. Un nouvel actionnement met fin à l'enregistrement.

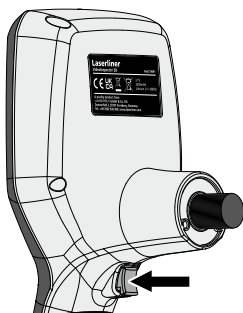

## 5 Mode de reproduction



### Reproduction d'images / d'enregistrement vidéo

Appuyer sur la touche « c » pour sélectionner la galerie média. En appuyant de nouveau sur la touche « c », le mode lecture est fermé.

### a. Lecture et suppression d'images / d'enregistrements vidéo

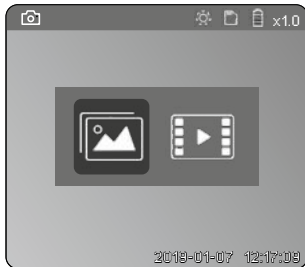

Sélection image / vidéo

Confirmer la sélection

#### Mode de lecture image

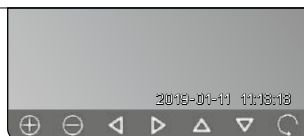
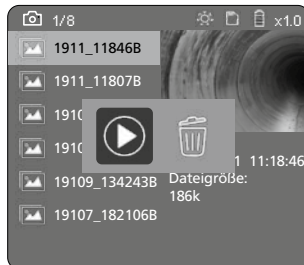
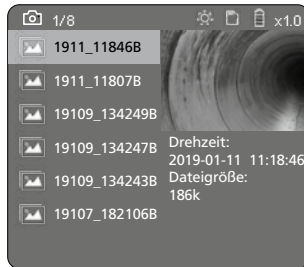

#### Mode de lecture vidéo

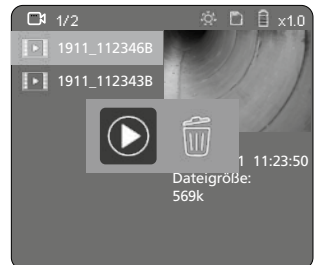
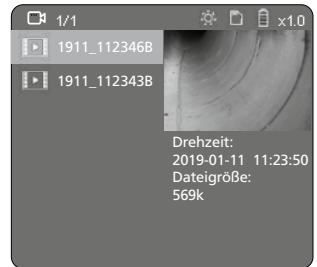

## b. Effacer l'enregistrement

Pour supprimer une photo ou un enregistrement vidéo, sélectionner la photo dans la vue d'ensemble des médias, voir chapitre 5a.

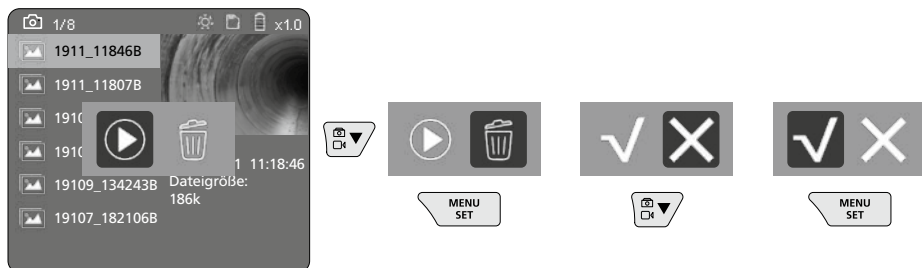

! Le processus de suppression ne peut pas être annulé.

! Le formatage du support de données permet d'effacer tous les fichiers et dossiers. Voir à ce sujet le point « 3 g. Formater le support de données ».

## Transmission des données par USB

Les données mémorisées sur la carte SD peuvent être transmises à un ordinateur en utilisant le lecteur de cartes fourni avec l'appareil.

## Tête de la caméra / foyer

Der Videoinspector 3D fournit des images nettes à une distance comprise entre 2,5 - 10 cm devant la tête de la caméra.

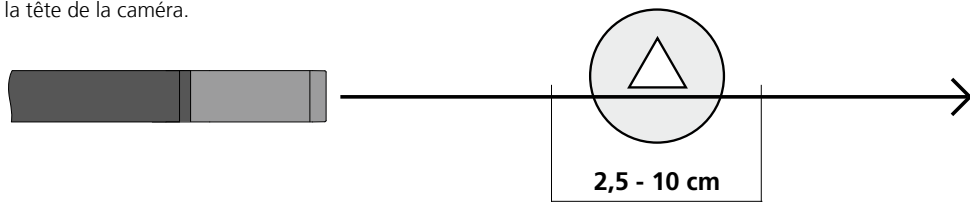

Les objets situés bien au-delà de cette zone peuvent apparaître en flou.

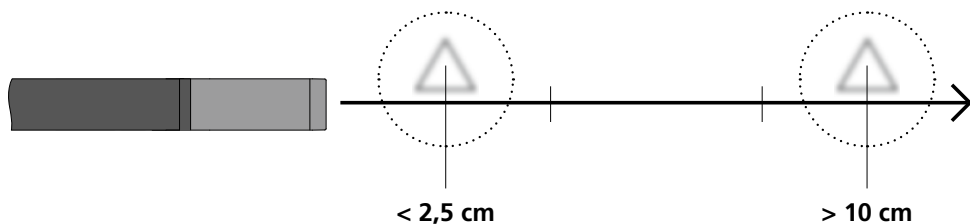

## Remplacement de l'accu

Retirer la fixation magnétique, ouvrir le compartiment pour la pile rechargeable et mettre la pile rechargeable en place en respectant les symboles de mise en place. Veillez à ce que la polarité soit correcte.

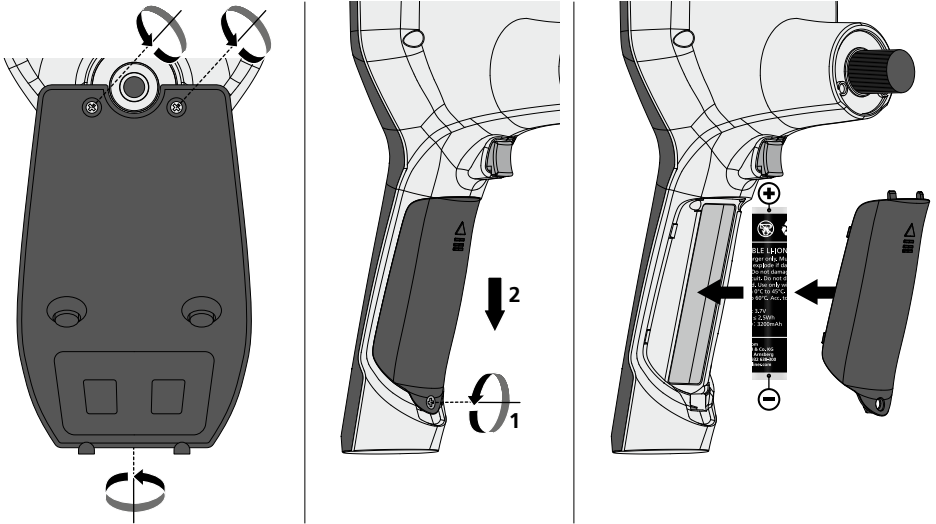

## Branchement du bloc secteur / chargeur

Pour recharger l'appareil, raccorder le bloc d'alimentation électrique/chargeur fourni avec l'appareil à l'interface micro USB / la prise de recharge « 6 » et le brancher à la source de courant adaptée.

## Remplacement de l'unité de la caméra

Il est possible d'enlever et de remplacer facilement l'unité de la caméra. Pour cela, desserrer la vis et retirer l'unité de la caméra au niveau du joystick.

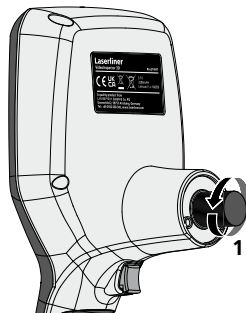

## Danger : puissants champs magnétiques

De puissants champs magnétiques peuvent avoir des effets néfastes sur des personnes portant des appareils médicaux (stimulateur cardiaque par ex.) et endommager des appareils électromécaniques (par ex. cartes magnétiques, horloges mécaniques, mécanique de précision, disques durs).

En ce qui concerne les effets de puissants magnétiques sur les personnes, tenir compte des directives et réglementations nationales respectives, comme, pour la république fédérale d'Allemagne, la directive de la caisse professionnelle d'assurance-maladie (BGV B11 §14) relative aux « champs magnétiques ».

Afin d'éviter toute influence gênante, veuillez toujours maintenir les aimants à une distance d'au moins 30 cm des implants et appareils respectivement en danger.

## Remarques concernant la maintenance et l'entretien

Nettoyer tous les composants avec un chiffon légèrement humide et éviter d'utiliser des produits de nettoyage, des produits à récurer ou des solvants. Retirer la/les pile(s) avant tout stockage prolongé de l'appareil. Stocker l'appareil à un endroit sec et propre.

Données techniques		Sous réserve de modifications techniques. 21W41
<b>Diamètre / Longueur Tête</b>	ø 6 mm / 74 mm	
<b>Type de l'écran</b>	Ecran d'affichage TFT de 3,5 po	
<b>Résolution de l'écran d'affichage</b>	640 x 480 pixels	
<b>Format de l'image / de la vidéo</b>	JPEG / MP4	
<b>Éclairage</b>	7 degrés de luminosité	
<b>Zoom numérique</b>	10 niveaux d'agrandissement	
<b>Mémoire</b>	Carte mémoire micro SD jusqu'à 8 GB	
<b>Type de protection</b>	Unité de base: IP 54 / Sonde de la caméra: IP 68 (Profondeur de plongée 1 m, 60 min)	
<b>Angle de flexion min. de la sonde</b>	75 mm	
<b>Connexions</b>	Micro USB, bloc d'alimentation électrique 5 V / CC	
<b>Résolution de la caméra</b>	960 x 720 pixels	
<b>Champ de vision (FOV)</b>	85°	
<b>Profondeur de champ (DOF)</b>	2,5 ... 10 cm	
<b>Diamètre / Longueur sonde</b>	6 mm / 2 m	
<b>Alimentation électrique</b>	Pack de pile rechargeable Li-ion 3,7 V / 1,7 Ah ; bloc d'alimentation électrique 5 V / CC / 2A	
<b>Durée de fonctionnement</b>	env. 3,5 heures	
<b>Temps de charge</b>	env. 4 heures	
<b>Conditions de travail</b>	-10°C ... 50°C, Humidité relative de l'air max. 20 ... 85% rH, non condensante, Altitude de travail max. de 4000 m au-dessus du niveau moyen de la mer	
<b>Conditions de stockage</b>	-20°C ... 60°C, Humidité relative de l'air max. 80% rH	
<b>Dimensions (L x H x P)</b>	115 x 190 x 115 mm (sans tuyau flexible ni fixation)	
<b>Poids</b>	485 g (pack d'accu et tuyau flexible inclus / sans fixation)	

## Réglementation UE et élimination des déchets

L'appareil est conforme à toutes les normes nécessaires pour la libre circulation des marchandises dans l'Union européenne.

Ce produit est un appareil électrique et doit donc faire l'objet d'une collecte et d'une mise au rebut sélectives conformément à la directive européenne sur les anciens appareils électriques et électroniques (directive DEEE).

Autres remarques complémentaires et consignes de sécurité sur

<http://laserliner.com/info?an=AIH>





**!** Lea atentamente las instrucciones y el libro adjunto de «Garantía e información complementaria», así como toda la información e indicaciones en el enlace de Internet indicado al final de estas instrucciones. Siga las instrucciones indicadas en ellas. Conserve esta documentación y entréguela con el dispositivo si cambia de manos.

## Funcionamiento y uso

Este videoinspector toma imágenes de vídeo en color con una micro cámara y las pone a disposición a través del LCD para hacer posible el control en puntos de difícil acceso como huecos, pozos, muros o vehículos.

## Indicaciones generales de seguridad

- Utilice el aparato únicamente para los usos previstos dentro de las especificaciones.
- Los instrumentos de medición y los accesorios no son juguetes infantiles.
  - Manténgalos fuera del alcance de los niños.
- No está permitido modificar la construcción del aparato.
- No exponga el aparato a cargas mecánicas, temperaturas muy elevadas, humedad o vibraciones fuertes.
- No se puede seguir utilizando el aparato cuando falla alguna función o la carga de la batería es débil.
- Cuando utilice el aparato al aire libre procure que sea usado bajo las condiciones meteorológicas adecuadas o con las medidas de protección correspondientes.
- Utilizar el alimentador de red o el cargador únicamente dentro de espacios cerrados; no exponer a la humedad ni a la lluvia, en caso contrario, existe riesgo de descarga eléctrica.
- Cargar completamente la batería antes de usar el aparato.
- Utilice única y exclusivamente el accesorio original. El uso de accesorios no autorizados anula la garantía.
- El proceso de carga finaliza cuando el piloto de servicio se enciende en verde.
- Si la carga de la batería es débil, aparece en pantalla un símbolo de batería rojo acompañado de un símbolo de exclamación.
- También se puede cargar la batería durante el funcionamiento.
- Disconnect the power pack from the mains when the device is not in use.
- No se puede sumergir la unidad LCD en agua. El aparato básico no debe estar en contacto con líquidos.
- El cabezal de la cámara no es resistente a los ácidos o el fuego.
- Es indispensable evitar que VideInspector 3D entre en contacto con sustancias químicas, corriente eléctrica, objetos móviles o calientes. Esto podría provocar daños en el aparato y causar lesiones graves al usuario.
- El cabezal de medición se puede calentar mucho con el servicio y causar daños en objetos sensibles.
- VideInspector 3D no se puede utilizar para realizar exámenes médicos o exploraciones en personas.
- Para garantizar la clase de protección IP 68 es imprescindible que esté bien cerrada la tapa de protección de las conexiones.
- Por favor respete las medidas de seguridad dispuestas por las autoridades locales o nacionales en relación al uso adecuado del aparato.
- El aparato no es apto para realizar mediciones cerca de tensión peligrosa. Por esa razón, las mediciones cerca de instalaciones eléctricas deberán ser realizadas con las piezas conductoras sin tensión. La ausencia de tensión y el seguro contra la conexión de nuevo tienen que estar garantizados por las medidas adecuadas.

## Instrucciones de seguridad

Modo de proceder con radiación óptica artificial según el OStrV (reglamento alemán de protección laboral contra la radiación óptica artificial)

### Orificio de salida del LED

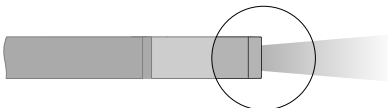

- El aparato trabaja con LED del grupo de riesgo RG 0 (grupo libre, sin riesgo) según las normas vigentes para la seguridad fotobiológica (EN 62471:2008-09ss / IEC/TR 62471:2006-07ss) en sus ediciones actuales.
- La radiación perceptible de los LED no es peligrosa para el ojo ni la piel humanos si se utiliza el aparato correctamente y en condiciones razonablemente previsible.

## Instrucciones de seguridad

### Manejo de radiación electromagnética

- El instrumento de medición cumple las normas y limitaciones de compatibilidad electromagnética según la Directiva 2014/30/UE de compatibilidad electromagnética (EMC).

## Instrucciones de seguridad

### Interferencias electromagnéticas

- El instrumento de medición cumple las normas y limitaciones de seguridad y compatibilidad electromagnética según la Directiva europea 2014/35/UE (baja tensión/LVD) y la Directiva 2014/30/UE (compatibilidad electromagnética/CEM).
- Es necesario observar las limitaciones de uso locales, por ejemplo en hospitales, aviones, gasolineras o cerca de personas con marcapasos. Se pueden producir efectos peligrosos o interferencias sobre los dispositivos electrónicos o por causa de estos.

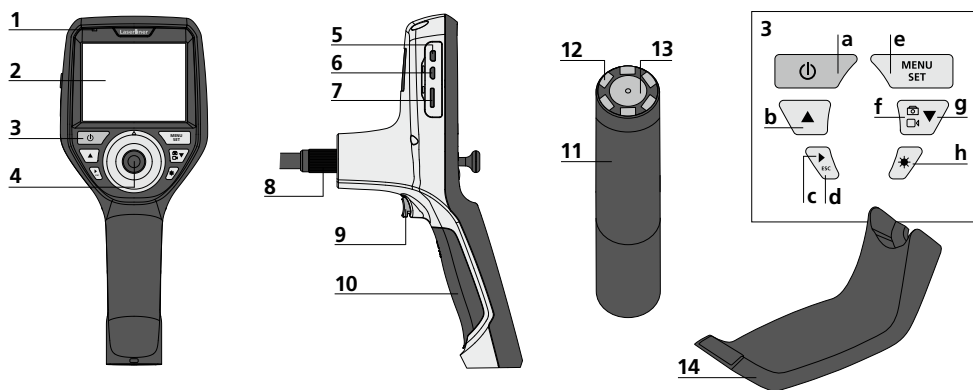

- |   |  |    |                              |   |  |   |                             |
|---|--|----|------------------------------|---|--|---|-----------------------------|
| 1 | Indicación de servicio                       | 7  | Ranura para tarjeta micro-SD | a | ON/OFF / Imagen fija   | f | Cambio entre imagen y vídeo |
| 2 | Pantalla LC                                  | 8  | Entrada tubo flexible        | b | Rotación 180° / Control del menú   | g | Control del menú            |
| 3 | Botones directos                             | 9  | Disparador                   | c | Galería de medios imagen y vídeo   | h | Iluminación LED             |
| 4 | Palanca para dirigir el cabezal de la cámara | 10 | Compartimento de pilas       | d | Cancelar   |   |                             |
| 5 | Interfaz para HDMI                           | 11 | Cabezal de la cámara         | e | Modo de configuración / Confirmar / Seleccionar grabaciones / Borrar tomas |   |                             |
| 6 | Puerto micro-USB / Entrada de carga          | 12 | LEDs                         |   |  |   |                             |
|   |  | 13 | Lente                        |   |  |   |                             |
|   |  | 14 | Soporte magnético            |   |  |   |                             |

**NOTA:** VideoInspector 3D proporciona imágenes nítidas en un rango de 2,5 a 10 cm por delante del cabezal de la cámara. Los objetos que se encuentren fuera del rango pueden aparecer desenfocados.

## Modo de toma de imágenes

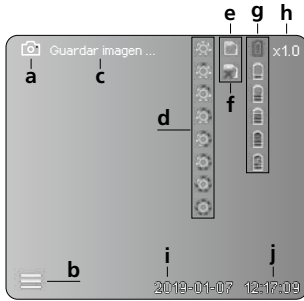

## Modo de grabación de vídeos

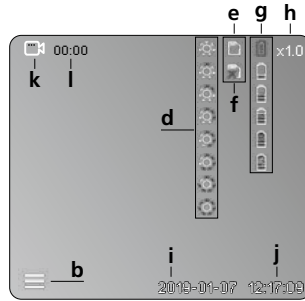

- a Tomar imagen
- b Menú cerrado
- c Guardando en memoria
- d Iluminación LED
- e Tarjeta SD activa
- f Introducir tarjeta SD
- g Estado de las pilas
- h Zoom
- i Fecha actual
- j Hora actual
- k Grabar vídeo
- l Grabando

## Modo de reproducción de imágenes



## Modo de reproducción de vídeos

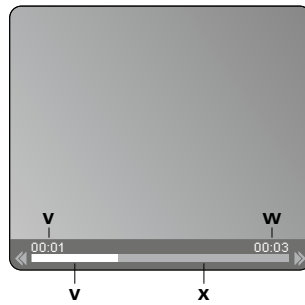

- m Fecha de la toma
- n Tiempo de grabación
- o Zoom +
- p Zoom -
- q Navegar por la imagen ampliada
- r Navegar por la imagen ampliada
- s Navegar por la imagen ampliada
- t Navegar por la imagen ampliada
- u Regresar a la galería de medios
- v Tiempo reproducido
- w Duración del vídeo
- x Tiempo restante

## Modo de configuración

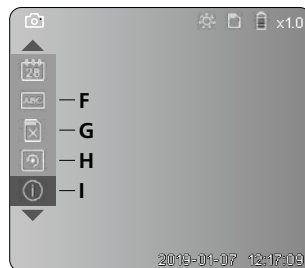
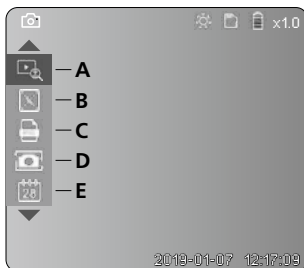

- A Zoom
- B Marca de fecha y hora
- C Formato de imagen
- D Rotación de imágenes
- E Ajustar fecha y hora
- F Cambiar idioma
- G Formatear soporte de datos
- H Configuración original
- I Versión del Firmware

## 1 ON / OFF



## 2 Modo de introducir la tarjeta micro-SD

Para colocar la tarjeta Micro-SD abra primero la tapa de goma e introduzca la tarjeta de memoria como se muestra en la imagen. Sin soporte de memoria no es posible realizar ninguna toma ni grabación.

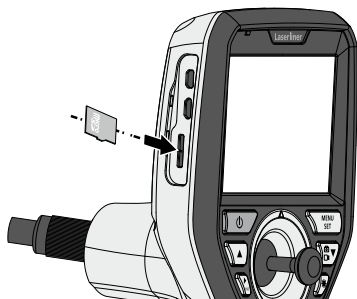

## 3 Modo de configuración

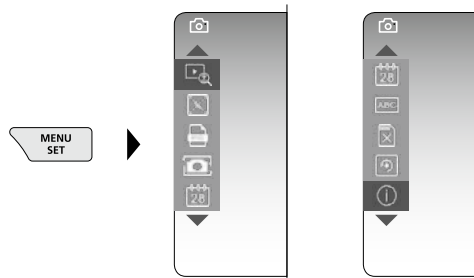

Para cambiar de nuevo al modo de grabación, pulse (varias veces) la ESC.

### a. Zoom

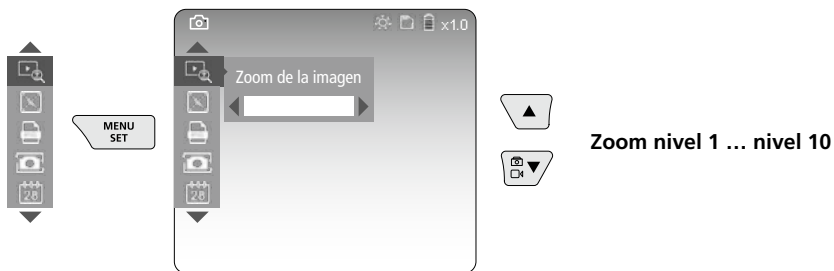

### b. Marca de fecha y hora

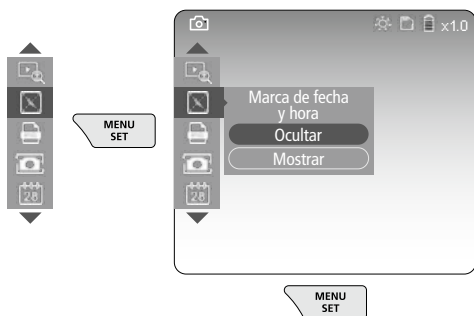

### c. Formato de imagen

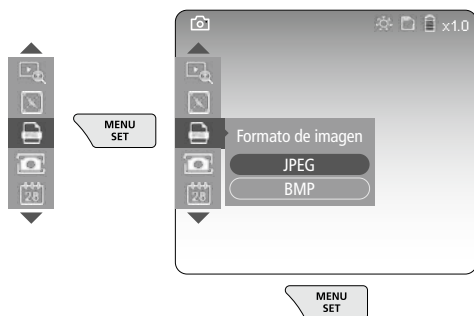



## h. Configuración original

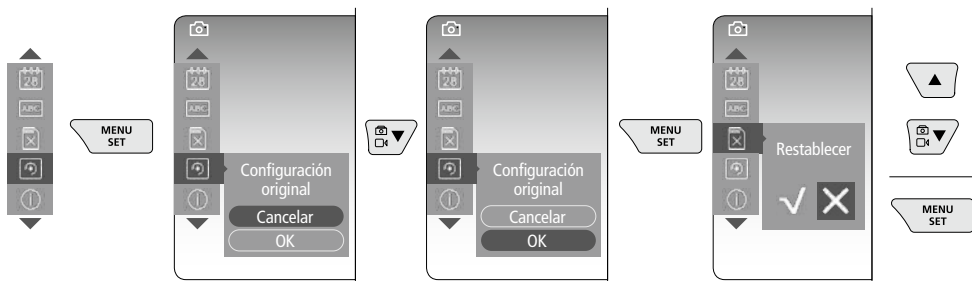

## i. Versión del Firmware / Actualización del sistema

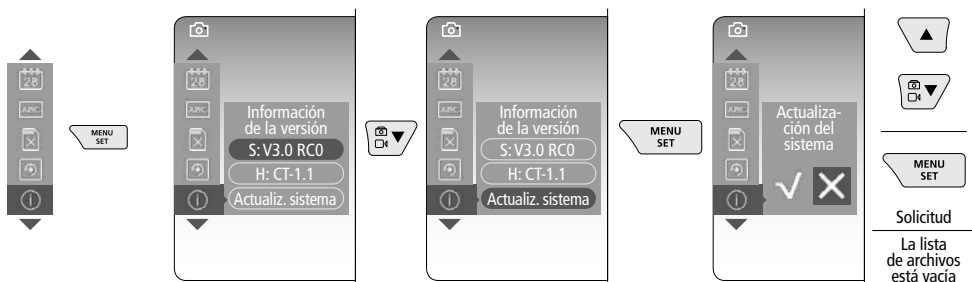

**!** Para efectuar una actualización del sistema, póngase en contacto con el Servicio técnico de UMAREX-LASERLINER.

## 4 Modo de grabación



### Toma de imágenes y vídeos

Dirija el cabezal de la cámara situado en el tubo flexible a la posición que desee y oriéntelo con la palanca (4). Si las condiciones lumínicas son malas encienda la iluminación LED. Acerque o amplíe los objetos que se encuentren alejados o sean muy pequeños. Con la rotación manual de imágenes se puede girar la imagen 90° en el monitor. Con una pulsación breve del botón de activación (9), se inicia la toma de imagen o la grabación de vídeo y se guarda en la tarjeta SD. Al pulsar de nuevo, finaliza la grabación.

## a. Cambio entre toma de imágenes y vídeos

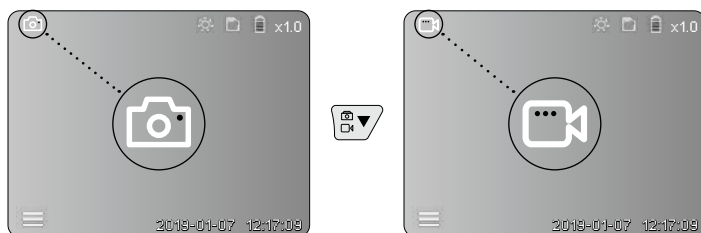

## b. Orientación del cabezal de la cámara

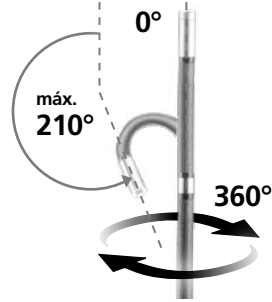
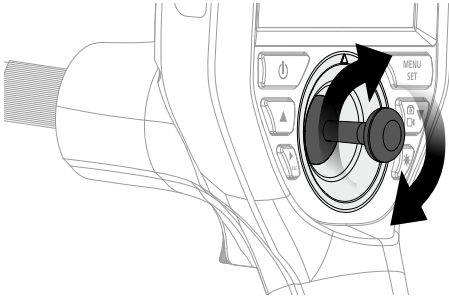

## c. Iluminación LED

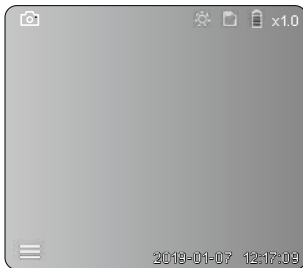

1x	⚙️	OFF
2x	⚙️	LED nivel 1
3x	⚙️	LED nivel 2
4x	⚙️	LED nivel 3
5x	⚙️	LED nivel 4
6x	⚙️	LED nivel 5
7x	⚙️	LED nivel 6
8x	⚙️	LED nivel 7

## d. Zoom (Ver el capítulo 3 a.)



## e. Rotación de imágenes

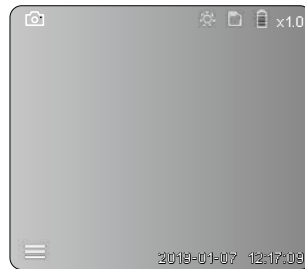

1x = Giro 90°

2x = Giro 90°

3x = Giro 90°

4x = Imagen inicial

## f. Toma de imágenes y vídeos

Con una pulsación breve del botón de activación (9), se inicia la toma de imagen o la grabación de vídeo y se guarda en la tarjeta SD. Al pulsar de nuevo, finaliza la grabación.

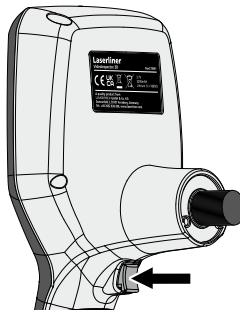

## 5 Modo de reproducción

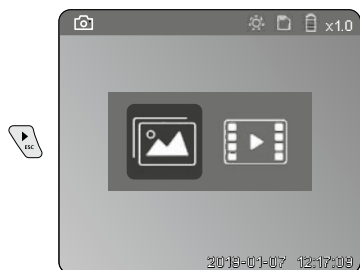

### Reproducción de fotos y vídeos

Con la tecla „c” se accede a la galería de medios. Pulsando de nuevo la tecla „c” se cierra el modo de reproducción.

### a. Reproducción y eliminación de las imágenes y vídeos

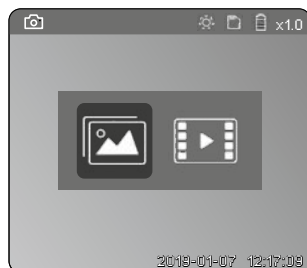

Seleccionar imagen / vídeo

Confirmar selección

#### Modo de reproducción de imágenes

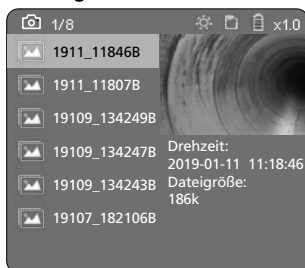

MENU SET

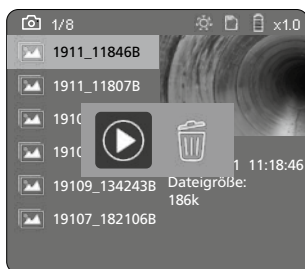

MENU SET

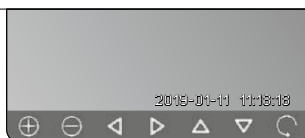

#### Modo de reproducción de vídeos

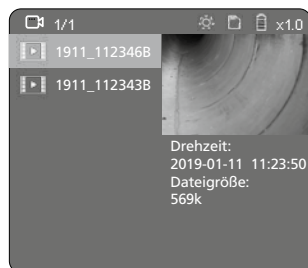

MENU SET

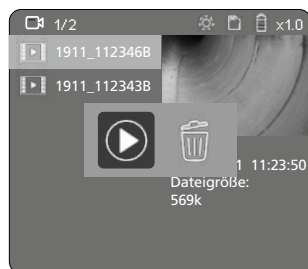

MENU SET





## b. Borrar toma

Para eliminar una imagen/vídeo, ábralo en la galería. Véase el capítulo 5 a.

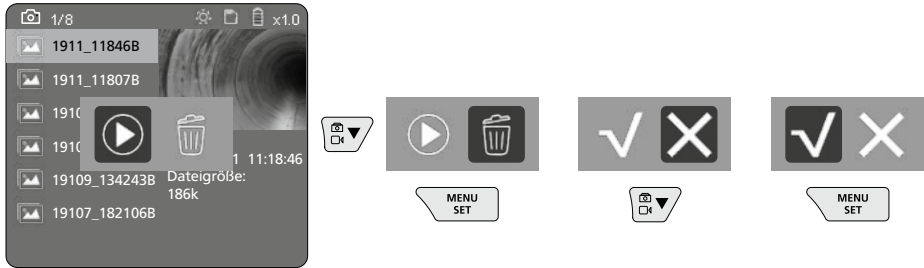

No se puede deshacer la operación de borrado.



Formateando el soporte de datos se puede borrar todos los archivos y carpetas. Ver al respecto el punto „3 g. Formatear soporte de datos“.

## Transmisión de datos por USB

La transmisión de los datos almacenados en la tarjeta SD puede efectuarse con el lector de tarjetas suministrado en el PC a través.

## Cabezal de la cámara y enfoque

VideInspector 3D proporciona imágenes nítidas en un rango de 2,5 a 10 cm por delante del cabezal de la cámara.

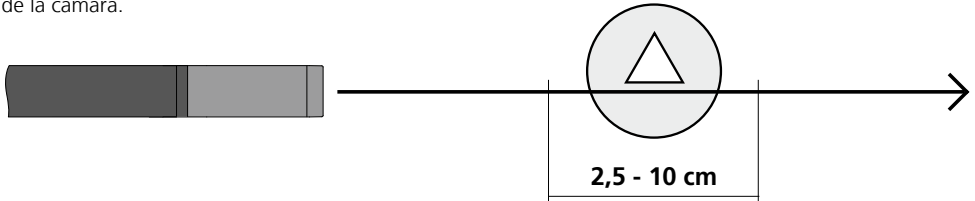

Los objetos que se encuentren fuera de ese rango pueden aparecer desenfocados.

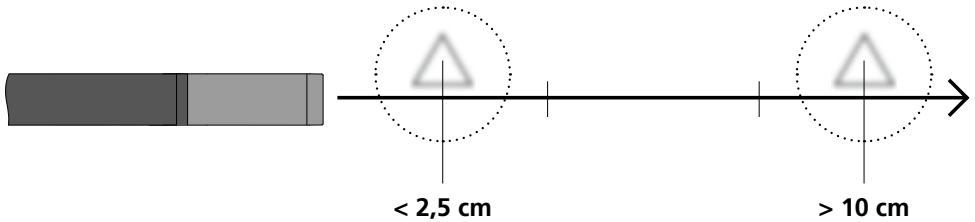

## Cambio de batería

Retire el soporte magnético, abra el compartimento de la batería y colóquela en la posición que indican los símbolos. Preste atención a la correcta polaridad.

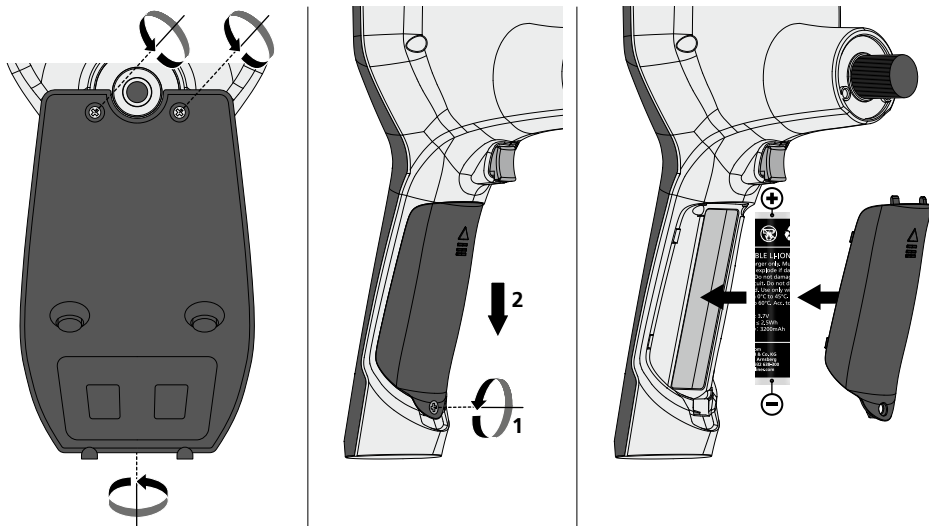

## Conectar alimentador de red / cargador

Para cargar el aparato, enchufe el alimentador de red/cargador adjunto en la interfaz micro USB/entrada de carga «6» y luego en la toma de corriente correspondiente.

## Sustitución de la unidad de la cámara

La unidad de la cámara se puede desmontar y sustituir fácilmente. Para ello, desenrosque el tornillo y extraiga la palanca.

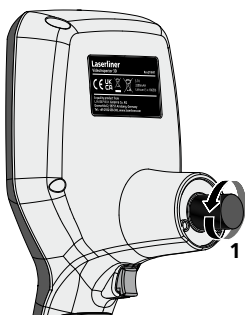

## Peligro por fuertes campos magnéticos

Los campos magnéticos fuertes pueden tener efectos dañinos en personas que utilicen dispositivos corporales activos (p. ej. marcapasos) y en equipos electromagnéticos (p. ej. tarjetas magnéticas, relojes mecánicos, mecanismos de precisión, discos duros).

En cuanto al efecto de los campos magnéticos fuertes sobre las personas deben tenerse en cuenta las disposiciones y normas nacionales pertinentes, por ejemplo en Alemania la norma de la mutua profesional BGV B11 artículo 14 „Campos electromagnéticos“.

Para evitar un efecto nocivo, mantenga los imanes siempre a una distancia mínima de 30 cm respecto a los dispositivos implantados y equipos que puedan ser afectados.

## Indicaciones sobre el mantenimiento y el cuidado

Limpie todos los componentes con un paño ligeramente humedecido y evite el uso de productos de limpieza, abrasivos y disolventes. Retire la/s pila/s para guardar el aparato por un periodo prolongado. Conserve el aparato en un lugar limpio y seco.

<b>Datos técnicos</b>		Sujeto a modificaciones técnicas. 21W41
<b>Diámetro / Longitud Cabezal</b>	ø 6 mm / 74 mm	
<b>Tipo de pantalla</b>	Pantalla TFT en color de 3,5"	
<b>Resolución de la pantalla</b>	640 x 480 pixel	
<b>Formato de las imágenes y vídeos</b>	JPEG / MP4	
<b>Iluminación</b>	7 niveles de brillo	
<b>Zoom digital</b>	10 niveles de zoom	
<b>Memoria</b>	Tarjeta micro SD de hasta 8 GB	
<b>Tipo de protección</b>	Unidad básica: IP 54 / Cabezal de la cámara: IP 68 (Profundidad de penetración 1 m, 60 min.)	
<b>Radio de flexión mín. de la sonda-cámara</b>	75 mm	
<b>Conexiones</b>	Micro-USB, fuente de alimentación 5V / DC	
<b>Resolución de la cámara</b>	960 x 720 pixel	
<b>Campo visual (FOV)</b>	85°	
<b>Profundidad de campo (DOF)</b>	2,5 ... 10 cm	
<b>Diámetro / Longitud Sonda</b>	6 mm / 2 m	
<b>Alimentación</b>	Batería Li-Ion 3,7V / 1,7Ah / Fuente de alimentación 5V/DC / 2A	
<b>Horas de servicio</b>	aprox. 3,5 h.	
<b>Tiempo de carga</b>	aprox. 4 h.	
<b>Condiciones de trabajo</b>	-10°C ... 50°C, humedad del aire máx. 20 ... 85% h.r., no condensante, altitud de trabajo máx. 4000 m sobre el nivel del mar (nivel normal cero)	
<b>Condiciones de almacén</b>	-20°C ... 60°C, humedad del aire máx. 80% h.r.	
<b>Medidas (An x Al x P)</b>	115 x 190 x 115 mm (sin tubo flexible y soporte)	
<b>Peso</b>	485 g (Bloque de batería y tubo flexible incluidos / sin soporte)	

## Disposiciones europeas y eliminación

El aparato cumple todas las normas requeridas para el libre tráfico de mercancías en la UE.

Se trata de un aparato eléctrico, por lo que debe ser recogido y eliminado por separado conforme a la directiva europea relativa a los aparatos eléctricos y electrónicos usados.

Más información detallada y de seguridad en: <http://laserliner.com/info?an=AIH>



! Leggere attentamente le istruzioni per l'uso, l'opuscolo allegato "Ulteriori informazioni e indicazioni garanzia", nonché le informazioni e le indicazioni più recenti raggiungibili con il link riportato al termine di queste istruzioni. Questo documento deve essere conservato e fornito insieme all'apparecchio in caso questo venga inoltrato a terzi.

## Funzione / Utilizzo

Questo ispettore video fornisce immagini a colori riprese da una microcamera e trasmesse all'LCD per il controllo di punti di difficile accesso, ad esempio cavità, cunicoli ed interstizi anche di autoveicoli.

## Indicazioni generali di sicurezza

- Utilizzare l'apparecchio esclusivamente in conformità con gli scopi previsti e nei limiti delle specificazioni.
- Gli apparecchi di misurazione e gli accessori non sono giocattoli. Conservare lontano dalla portata di bambini.
- La struttura dell'apparecchio non deve essere modificata.
- Non sottoporre l'apparecchio a carichi meccanici, elevate temperature, umidità o forti vibrazioni.
- Non utilizzare più l'apparecchio in caso di guasto di una o più funzioni oppure se le batterie sono quasi scariche.
- In esterni l'apparecchio può essere utilizzato solo con determinate condizioni atmosferiche o con appropriate misure di sicurezza.
- Utilizzare l'alimentatore/il caricabatterie solo in locali chiusi evitando di esporlo all'umidità o alla pioggia altrimenti si corre il rischio di scosse elettriche.
- Prima di utilizzare l'apparecchio caricare completamente l'accumulatore.
- Utilizzare esclusivamente gli accessori originali. L'uso di accessori non conformi annulla la garanzia.
- Il processo di ricarica termina quando si accende la spia della batteria verde.
- Se la batteria è quasi scarica, sul display compare un'icona della batteria rossa con un punto esclamativo.
- La batteria può essere ricaricata anche mentre l'apparecchio è in funzione.
- Se l'apparecchio non deve essere utilizzato staccare l'alimentatore dalla rete.
- L'unità LCD non deve essere immersa in acqua. L'apparecchio base non deve venire a contatto con liquidi.
- La testina di ripresa non resiste agli acidi o al fuoco.
- Evitare assolutamente che il sistema Videolnspector 3D venga a contatto con sostanze chimiche, tensione e oggetti in movimento o molto caldi. Ciò potrebbe danneggiare l'apparecchio e causare anche gravi lesioni dell'utente.
- Durante il funzionamento la testina di misura può surriscaldarsi e causare danni ai materiali da misurare che sono delicati.
- Il sistema Videolnspector 3D non deve essere utilizzato per indagini mediche o per eseguire esami su persone.
- Per garantire la classe di protezione IP 68, il cappuccio protettivo degli attacchi deve essere perfettamente chiuso.
- Attenersi alle misure di sicurezza stabilite dagli enti locali e nazionali relative al corretto utilizzo dell'apparecchio.
- L'apparecchio non è adatto a misurazioni nelle vicinanze di tensioni pericolose. Pertanto, per eseguire misurazioni nelle vicinanze di impianti elettrici, assicurarsi sempre che gli elementi conduttivi non siano sotto tensione. Garantire l'assenza di tensione e la protezione da riattivazione prendendo dei provvedimenti adeguati.

## Indicazioni di sicurezza

Manipolazione con radiazioni ottiche artificiali secondo l'ordinanza tedesca OStrV.

## Apertura di uscita LED

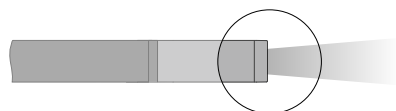

# VideInspector 3D

- L'apparecchio funziona con LED appartenenti al gruppo di rischio RG 0 (gruppo esente, nessun rischio) ai sensi delle norme vigenti per la sicurezza fotobiologica (EN 62471:2008-09ff / IEC/TR 62471:2006-07ff) nelle sue attuali versioni.
- Se si rispetta la destinazione d'uso dei LED e li si utilizza in condizioni ragionevolmente prevedibili, la loro radiazione accessibile non è pericolosa per l'occhio e la pelle umani.

## Indicazioni di sicurezza

Lavorare in presenza di radiazione elettromagnetica

- L'apparecchio rispetta le norme e i valori limite per la compatibilità elettromagnetica ai sensi della direttiva EMC 2014/30/UE.

## Indicazioni di sicurezza

Gestione delle interferenze elettromagnetiche

- Questo apparecchio di misura rispetta le disposizioni e i valori limite per la sicurezza e la compatibilità elettromagnetica ai sensi delle Direttive 2014/35/UE (Direttiva Bassa Tensione / LVD) e 2014/30/UE (Direttiva Compatibilità Elettromagnetica / EMC).
- Rispettare le restrizioni locali all'uso, ad es. in ospedali, a bordo di aerei, in stazioni di servizio o nelle vicinanze di persone portatrici di pacemaker. Presenza di un influsso pericoloso o di un disturbo degli e da parte degli apparecchi elettronici.

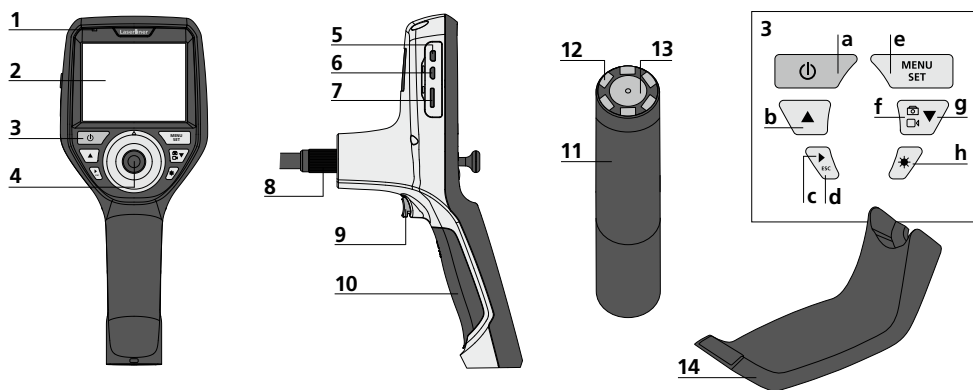

- |   |   |    |                            |   |  |   |                               |
|---|---|----|----------------------------|---|--|---|-------------------------------|
| 1 | Indicatore di funzionamento                       | 7  | Slot scheda micro SD       | a | ON/OFF / Immagine fissa  | f | Commutazione immagine / video |
| 2 | Display LC  | 8  | Connettore tubo flessibile | b | Rotazione 180° / Comando menu  | g | Comando menu                  |
| 3 | Tasti di avvio rapido                             | 9  | Scatto                     | c | Galleria immagini e video  | h | LED di illuminazione          |
| 4 | Leva di comando per ruotare la testina di ripresa | 10 | Vano delle pile            | d | Interrompi   |   |                               |
| 5 | Interfaccia HDMI                                  | 11 | Testina di ripresa         | e | Modalità di impostazione / Conferma / Accedi alle registrazioni / Cancella ripresa |   |                               |
| 6 | Interfaccia micro USB / Connettore di ricarica    | 12 | LED's                      |   |  |   |                               |
|   |   | 13 | Lente                      |   |  |   |                               |
|   |   | 14 | Supporto magnetico         |   |  |   |                               |

**NOTA:** Il sistema VideInspector 3D fornisce immagini nitide registrate in un campo tra 2,5 e 10 cm davanti alla testina di ripresa. Le immagini degli oggetti a distanza maggiore o minore possono essere sfocate.

## Modalità di ripresa immagini

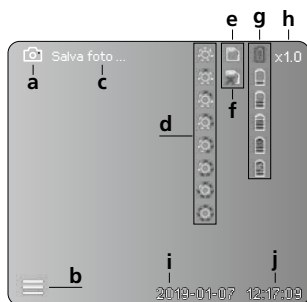

## Modalità di ripresa video

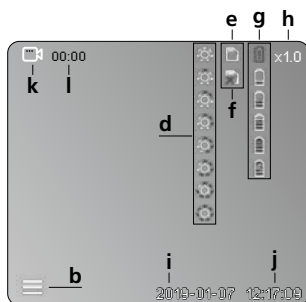

- a Ripresa immagine
- b Menu chiuso
- c Memorizzazione
- d LED di illuminazione
- e Scheda SD attiva
- f Inserire scheda SD
- g Stato delle batterie
- h Zoom
- i Data attuale
- j Ora attuale
- k Ripresa video
- l Registrazione in corso

## Modalità riproduzione immagine

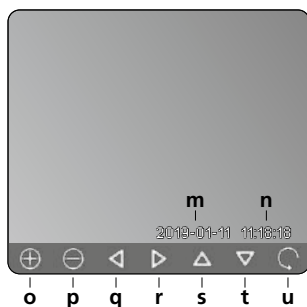

## Modalità riproduzione video

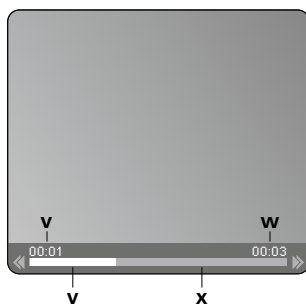

- m Data ripresa
- n Durata registrazione
- o Zoom +
- p Zoom -
- q Naviga nell'immagine zoomata
- r Naviga nell'immagine zoomata
- s Naviga nell'immagine zoomata
- t Naviga nell'immagine zoomata
- u Indietro alla galleria immagini
- v Tempo di riproduzione trascorso
- w Durata ripresa
- x Tempo residuo

## Modalità di impostazione

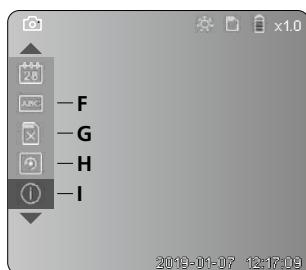
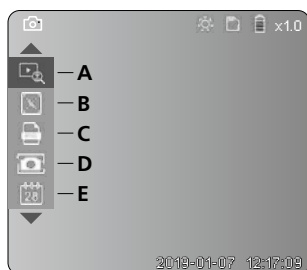

- A Zoom
- B Data e orario
- C Formato immagine
- D Rotazione immagine
- E Impostazione data/ora
- F Modifica lingua
- G Formattazione supporto dati
- H Impostazione di fabbrica
- I Versione firmware

## 1 ON / OFF



## 2 Inserimento della microscheda SD

Per inserire la microscheda SD, aprire la copertura in gomma e inserire la scheda come indicato nell'immagine. Senza un supporto di memorizzazione non sono possibili le registrazioni.

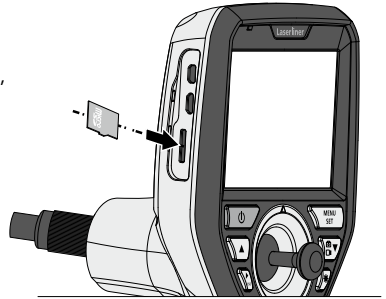

## 3 Modalità di impostazione

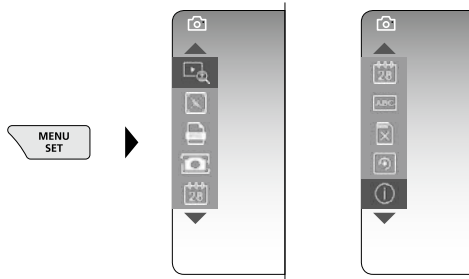

Per ritornare alla modalità di ripresa, premere (ripetutamente) il tasto ESC.

### a. Zoom

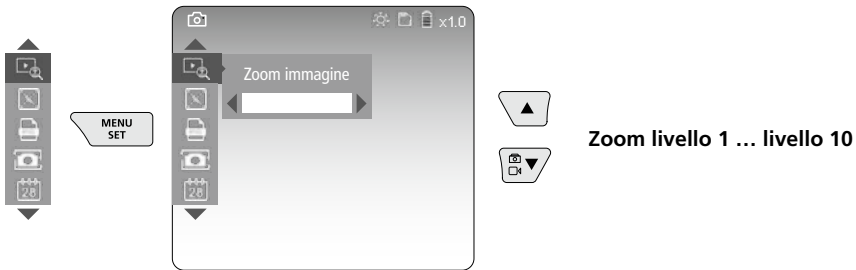

### b. Data e orario

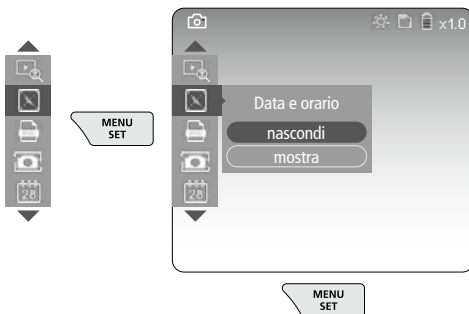

### c. Formato immagine

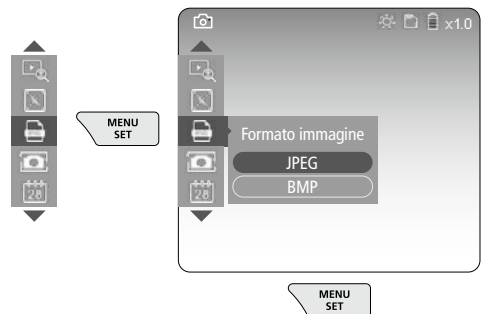

## d. Rotazione immagine

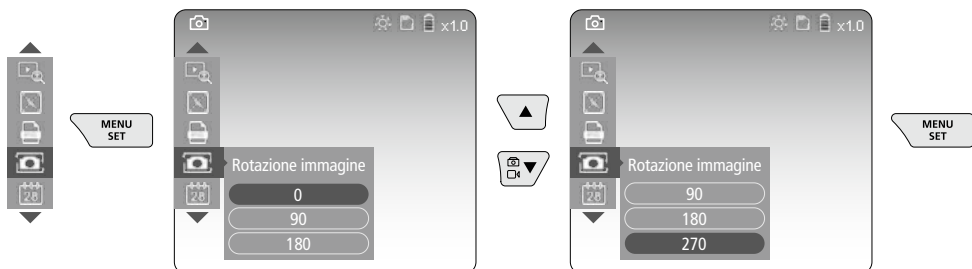

## e. Impostazione data / ora

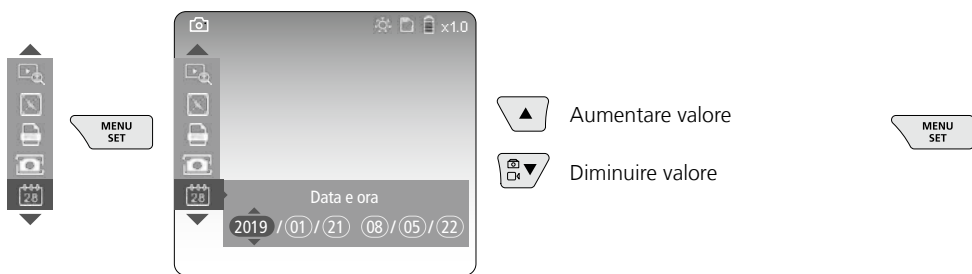

## f. Modifica lingua (ZH-CN, ZH-TW, EN, JA, KO, FR, DE, PT, ES, RU, IT, NL)

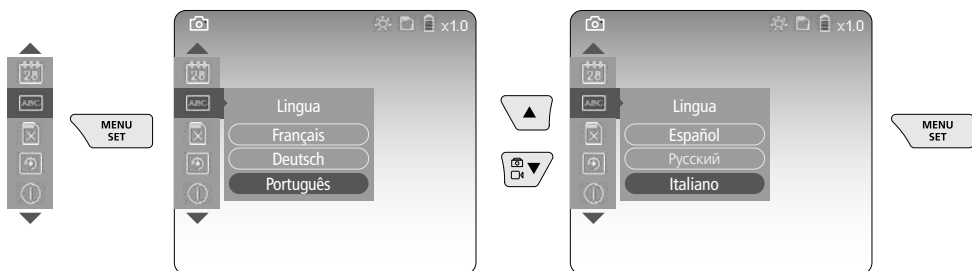

## g. Formattazione supporto dati

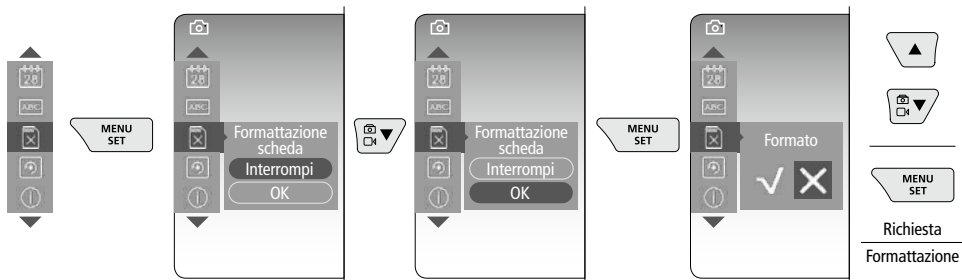



## h. Impostazione di fabbrica

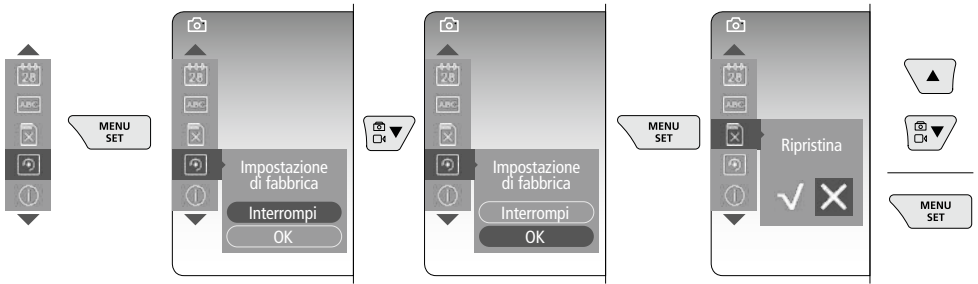

## i. Versione firmware / Aggiornamento del sistema

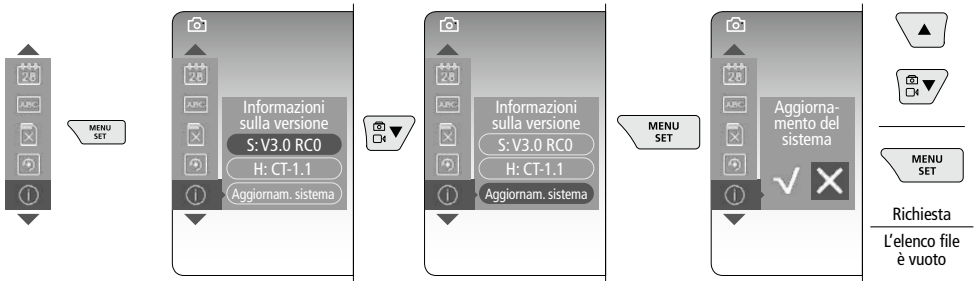

**!** Per eseguire un aggiornamento di sistema rivolgersi al reparto assistenza della UMAREX-LASERLINER.

## 4 Modalità di ripresa

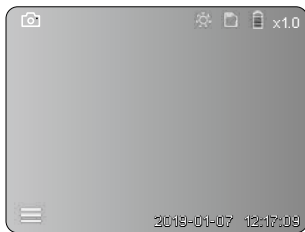

### Ripresa di immagini / video

Portare nella posizione necessaria la testina di ripresa sul tubo flessibile e orientarla con la leva di comando (4). In caso di luce insufficiente accendere il LED di illuminazione. Utilizzare lo zoom per ingrandire oggetti piccoli o lontani. L'immagine sul monitor può essere ruotata di 90° con la funzione di rotazione manuale. Premendo brevemente il tasto a grilletto (9) si esegue la ripresa di immagini o video che vengono memorizzate sulla scheda SD. Premendolo di nuovo termina la registrazione video.

## a. Commutazione registrazione immagine / video

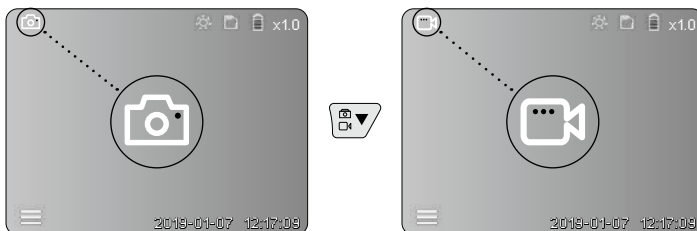

## b. Orientamento della testina di ripresa

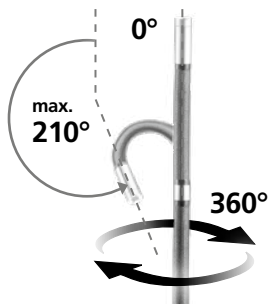
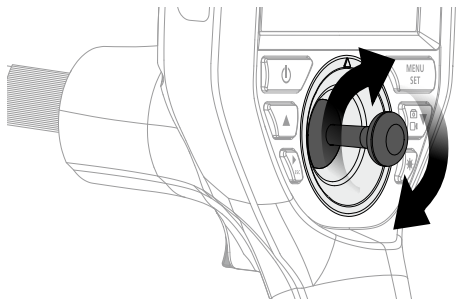

## c. LED di illuminazione

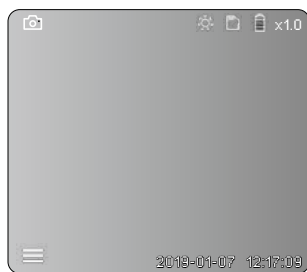

1x	⚙️	OFF
2x	⚙️	LED livello 1
3x	⚙️	LED livello 2
4x	⚙️	LED livello 3
5x	⚙️	LED livello 4
6x	⚙️	LED livello 5
7x	⚙️	LED livello 6
8x	⚙️	LED livello 7

## d. Zoom (v. capitolo 3.a)

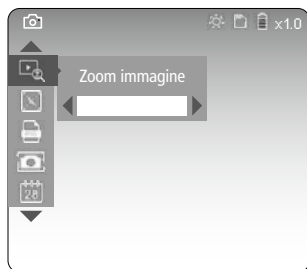

## e. Rotazione immagine

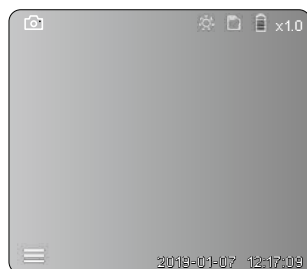

- 1x = Rotazione a 90°
- 2x = Rotazione a 90°
- 3x = Rotazione a 90°
- 4x = Immagine iniziale

## f. Registrazione immagine / video

Premendo brevemente il tasto a grilletto (9) si esegue la ripresa di immagini o video che vengono memorizzate sulla scheda SD. Premendolo di nuovo termina la registrazione video.



## 5 Modalità di riproduzione



### Riproduzione di immagini / video

Premendo il tasto „c” si accede alla galleria immagini e video. Premendo nuovamente il tasto „c”, la modalità di riproduzione viene chiusa.

### a. Riproduzione e cancellazione delle registrazioni di immagini / video

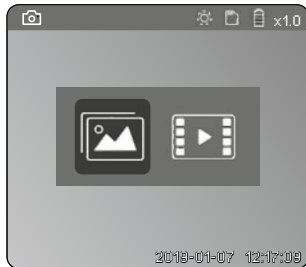

Seleziona immagine / video



Conferma selezione

#### Modalità riproduzione immagine

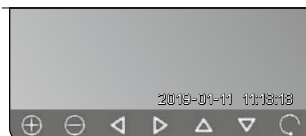
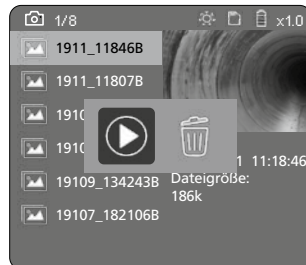
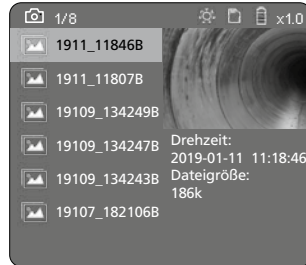

#### Modalità riproduzione video

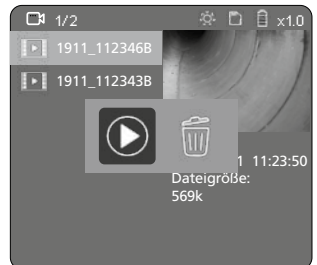
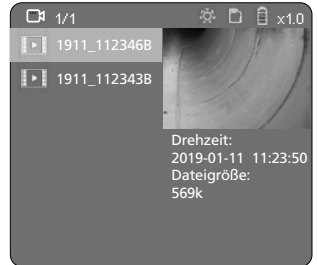

## b. Cancella ripresa

Per cancellare una registrazione di immagini o video accedere all'immagine nella galleria immagini, v. capitolo 5 a.

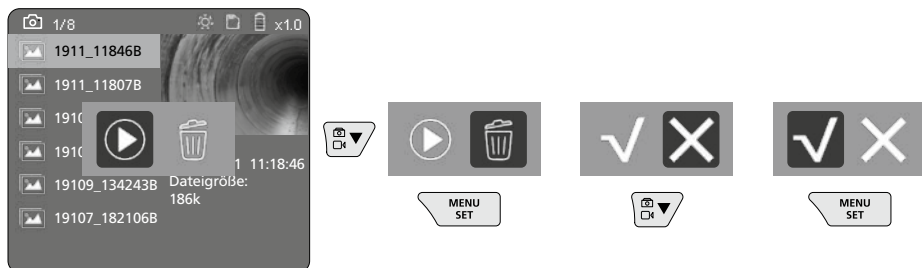

! L'operazione di cancellazione non può essere annullata.

! Formattando il supporto dati si possono cancellare tutti i file e tutte le cartelle.  
A riguardo vedi punto „3 g. Formattazione supporto dati“.

## Trasmissione dati USB

I dati salvati sulla scheda SD possono essere trasferiti al PC con il lettore di schede fornito in dotazione.

## Testina di ripresa / Distanza focale

Il sistema Videolnspector 3D fornisce immagini nitide registrate in un campo tra 2,5 e 10 cm davanti alla testina di ripresa.

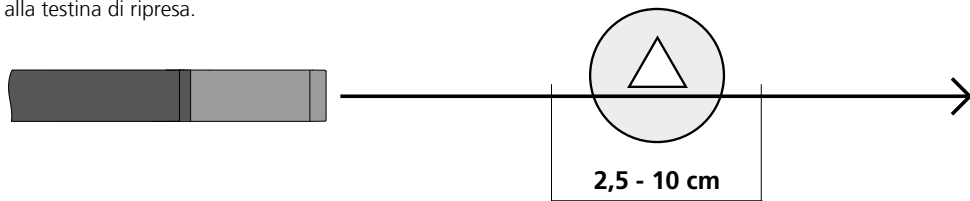

Le immagini degli oggetti a distanza maggiore o minore possono essere sfocate.

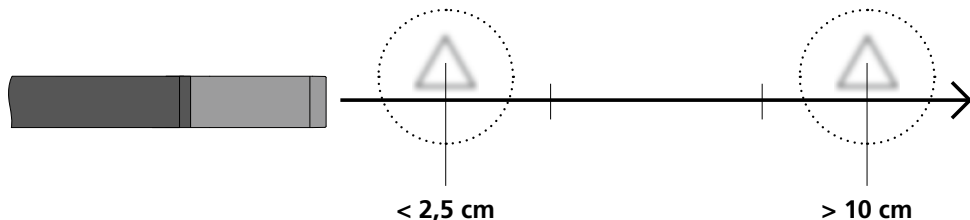

## Sostituzione delle batterie

Togliere il supporto magnetico, aprire il vano batteria e inserire la batteria rispettando i simboli per l'installazione. Fare attenzione alla corretta polarità.

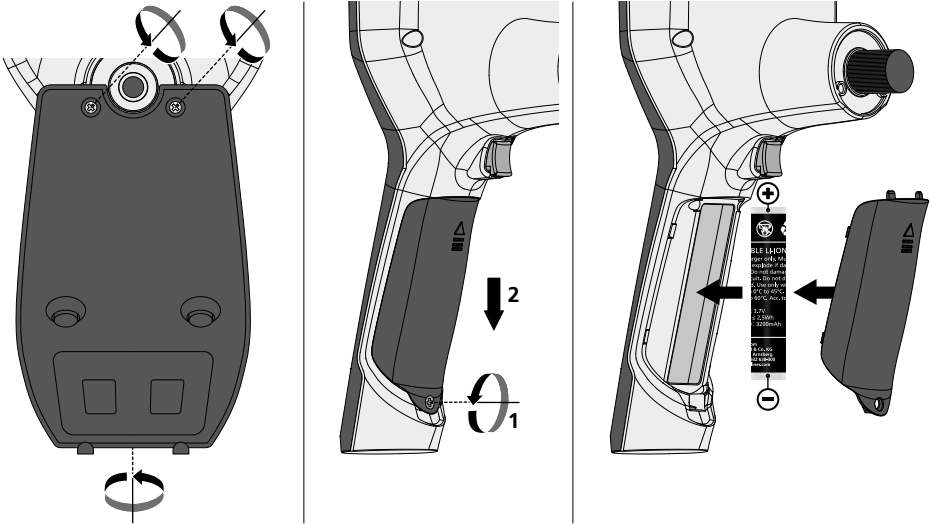

## Collegare alimentatore / caricabatteria

Per caricare l'apparecchio collegare l'alimentatore/il caricabatterie in dotazione all'interfaccia Micro USB / alla presa "6" e collegarlo a un rispettivo punto di alimentazione di corrente.

## Sostituzione dell'unità obiettivo

L'unità obiettivo può essere facilmente rimossa e sostituita. In tal caso allentare le viti ed estrarre l'unità obiettivo agendo sulla leva di comando.

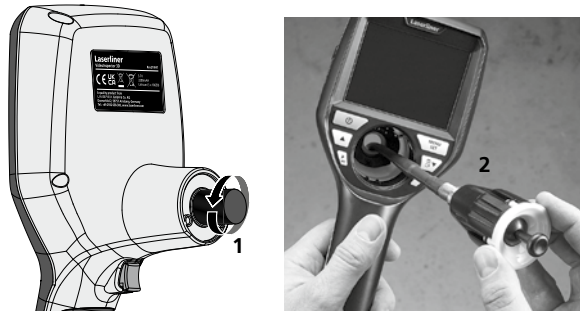

## Pericoli causati da forti campi magnetici

Forti campi magnetici possono causare danni a persone con ausili fisici attivi (per es. pacemaker) e ad apparecchi elettromeccanici (per es. schede magnetiche, orologi magnetici, meccanica fine, dischi fissi).

A causa dell'influenza di forti campi magnetici su persone, vanno rispettate le rispettive disposizioni e norme nazionali, ad esempio in Germania la norma BGV B11 §14 „Campi elettromagnetici“.

Pe evitare disturbi, tenere i magneti sempre a una distanza di almeno 30 cm dai rispettivi impianti e apparecchi.

## Indicazioni per la manutenzione e la cura

Pulire tutti i componenti con un panno leggermente inumidito ed evitare l'impiego di prodotti detergenti, abrasivi e solventi. Rimuovere la batteria/le batterie prima di un immagazzinamento prolungato. Immagazzinare l'apparecchio in un luogo pulito e asciutto.

### Dati tecnici

Con riserva di modifiche tecniche 21W41

<b>Diametro / Lunghezza Testina di ripresa</b>	ø 6 mm / 74 mm
<b>Tipo di display</b>	Display a colori TFT da 3,5"
<b>Risoluzione del display</b>	640 x 480 pixel
<b>Formato immagine / video</b>	JPEG / MP4
<b>Illuminazione</b>	7 livelli di luminosità
<b>Zoom digitale</b>	10 livelli zoom
<b>Memoria</b>	Scheda di memoria microSD fino a 8 GB
<b>Schutzart</b>	Unità base: IP 54 / Sonda: IP 68 (profondità d'immersione 1 m, 60 min.)
<b>Raggio di curvatura min. Sonda</b>	75 mm
<b>Attacchi</b>	Micro-USB, alimentatore 5V / DC
<b>Risoluzione telecamera</b>	960 x 720 pixel
<b>Campo visivo (FOV)</b>	85°
<b>Profondità di campo (DOF)</b>	2,5 ... 10 cm
<b>Diametro / Lunghezza Sonda</b>	6 mm / 2 m
<b>Alimentazione elettrica</b>	Gruppo batterie agli ioni di litio da 3,7V / 1,7Ah; / Alimentatore 5V/DC / 2A
<b>Durata di esercizio</b>	ca. 3,5 ore
<b>Durata di carica</b>	ca. 4 ore
<b>Condizioni di lavoro</b>	-10°C ... 50°C, umidità dell'aria max. 20 ... 85% rH, non condensante, altezza di lavoro max. 4000 m sopra il livello del mare (zero normale)
<b>Condizioni di stoccaggio</b>	-20°C ... 60°C, umidità dell'aria max. 80% rH
<b>Dimensioni (L x A x P)</b>	115 x 190 x 115 mm (senza tubo flessibile e supporto)
<b>Peso</b>	485 g (inclusi gruppo batterie e tubo flessibile / senza supporto)

### Norme UE e smaltimento

L'apparecchio soddisfa tutte le norme necessarie per la libera circolazione di merci all'interno dell'UE.

Questo prodotto è un apparecchio elettrico e deve pertanto essere raccolto e smaltito separatamente in conformità con la direttiva europea sulle apparecchiature elettriche ed elettroniche usate.

Per ulteriori informazioni ed indicazioni di sicurezza: <http://laserliner.com/info?an=AIH>





# VideoInspector 3D



**SERVICE**



## **Umarex GmbH & Co. KG**

– Laserliner –

Möhnstraße 149, 59755 Arnsberg, Germany

Tel.: +49 2932 638-300, Fax: +49 2932 638-333

info@laserliner.com

082.275.56 / Rev2 1W41

Umarex GmbH & Co. KG

Donnerfeld 2

59757 Arnsberg, Germany

Tel.: +49 2932 638-300, Fax: -333

www.laserliner.com



**Laserliner**